

529x396 R12
R35,5
1.40
7
8

SEZIONE A-A

A



Plastica Panaro
PACKAGING & HARDWARE

Codice valigia: MAX540 H190
Materiali: P.P. Copolimero

NOTE:	Fondo intern.
ALE	



REACH ✓

RoHS ✓

Dir.
94/62/CE ✓

IP67 ✓

MIL SPECS
DEF STAN 81-41
STANAG 4280 ✓

ATA 300 ✓

Una Lunga Storia

Da oltre 50 anni sviluppiamo soluzioni in plastica per trasportare, organizzare e proteggere le attrezzature dei nostri clienti. DNA italiano. Spirito internazionale.

Fondata nel 1962 come un piccolo laboratorio familiare di scatole da pesca, Plastica Panaro si è evoluta nel corso degli anni aumentando in modo esponenziale la propria gamma di prodotti.

Oggi siamo un'azienda forte e strutturata. Con 3 stabilimenti ed una forza lavoro di oltre 80 dipendenti, progettiamo e sviluppiamo centinaia di soluzioni innovative per il mercato dell'hardware, del packaging, dell'equitazione, della pesca e della termoformatura.

Unsere Geschichte

Unser Unternehmen entwickelt seit über 50 Jahren Lösungen, um Ihre Produkte zu transportieren, zu ordnen und zu schützen. Italienische DNA. Internationaler Geist.

Das Unternehmen wurde im Jahr 1962 als kleiner Familienbetrieb gegründet und stellte Anfangs Angel- und Kunststoffkofferlösungen her. Es hat sich durch die Jahre weiterentwickelt und die Produktpalette kontinuierlich erweitert.

Plastica Panaro bietet nun Komplettlösungen wie Design, Entwicklung und Fertigungsservice an. Wir haben die Möglichkeit unendliche Lösungen für die Bereiche Verpackung, Werkzeugkoffer, Reit- und Angelsport sowie Tiefziehprodukte anzubieten.

Mit drei Werken und über 80 Mitarbeitern sind wir in der Lage, mit den internationalen Mitbewerbern Schritt zu halten und unsere Produkte auf allen wichtigen Messen weltweit auszustellen.

The Story

We have been developing plastic solutions to carry, organize and protect our customer's gear for over 50 years. Italian DNA. International spirit.

Founded in 1962 as a small family workshop of tackle boxes and plastic case solutions, the company has evolved throughout the years and has continuously expanded its product range. Now Plastica Panaro is a full service company, offering design, development and manufacturing services. We are able to create hundreds of innovative solutions for hardware, packaging, equestrianism, fishing and thermoforming markets. With 3 plants and a workforce of over eighty employees, we are able to keep up with the best global players in the market and show our products at all the main trade fairs worldwide.

Notre Longue Histoire

Depuis plus de 50 ans, nous développons des solutions plastique pour transporter, organiser et protéger le matériel de nos clients. ADN italien. Esprit international.

Fondée en 1962 comme petit atelier familial de fabrication de boîtes de pêche et de boîtes en plastique, la société a évolué au fil des années et n'a cessé d'élargir sa gamme de produits. Aujourd'hui, Plastica Panaro est une société de services complète proposant des services de conception, de développement et de fabrication. Nous sommes en mesure de créer des centaines de solutions innovantes pour les marchés de l'outillage, de l'emballage, de l'équitation, de la pêche et du thermoformage.

Avec 3 établissements et un effectif de plus de quatre-vingts employés, nous sommes en mesure de nous positionner parmi les meilleurs acteurs mondiaux du marché et de présenter nos produits dans tous les principaux salons internationaux.



Più di 55 anni di esperienza
More than 55 years of know-how
55 Jahre Erfahrung
55 ans d'expérience



Uno staff di oltre 80 persone
Staff of over 80 people
80 Mitarbeiter
80 collaborateurs



Produzione a ciclo continuo
24 H production
24-H- Produktion
Production continue



100% soddisfazione cliente
100% customer satisfaction
100% Kundenzufriedenheit
100% de satisfaction client



Distribuzione internazionale
Worldwide distribution
Weltweiter Vertrieb
Réseau de distribution international

 Dimensioni interne / *Internal dimensions / Innenmaße / Dimensions internes*

 Dimensioni esterne / *External dimensions / Außenmaße / Dimensions externes*

 Profondità coperchio-fondo / *Lid-bottom depth / Tiefe Deckel-Boden / Profondeur couvercle-fond*

 Peso / *Weight / Gewicht / Poids*

 Colori / *Colours / Farben / Couleurs*

 Spugne / *Foams / Schaumstoffe / Mousses*





VALIGIE ERMETICHE
Watertight cases



PROCASE
Proc case Series



ADVANCED
Advanced Series



CLASSIC
Classic Series



K LINE
K Series



SCATOLE E BLISTER
Boxes and blisters

Valigie ermetiche / Watertight cases / Wasserdichte Koffer / Valises étanches



Le valigie MAX Cases sono certificate IP67, abilitate alle norme STANAG 4280 e DEF STAN 81-41 e codificate NATO (NSN). L'eccezionale resistenza ad urti, polvere ed agenti atmosferici rende queste valigie ottimali per molteplici campi d'applicazione tra cui sicurezza, forze dell'ordine, militare, caccia e outdoor, nautica, fotografia, broadcasting e diversi altri settori dell'industria manifatturiera.

Max Cases are our watertight line, which was created to offer superior protection from the elements, water, dust and impacts when transporting fragile and valuable objects. IP67 and military certifications make these cases suitable for a wide range of applications such as marine, photography & broadcasting, scuba diving, outdoor sports, medical, military, special corps and even the manufacturing industry.



Unsere wasserdichte Produktreihe „Max Koffer“ bietet einen hervorragenden Schutz vor Witterungseinflüssen, Wasser, Staub und Stößen während des Transports zerbrechlicher und wertvoller Gegenstände. Aufgrund der IP67- und Militäرزertifizierungen eignen sich diese Koffer für eine breite Palette von Anwendungen wie z.B. Marine, Fotografie, Rundfunk, Tauchen, Outdoor-Sport, Medizintechnik, Militär, Spezialeinheiten und sogar Fertigungsindustrie.

MAX CASES est notre gamme étanche, conçue pour offrir une protection supérieure contre les éléments : l'eau, la poussière et les impacts, lors du transport d'équipements fragiles et de grande valeur. Les certifications IP67 et militaires rendent ces valises de transport adaptées à un large éventail d'applications telles que le secteur nautique, la photographie et la radiodiffusion, la plongée sous-marine, les sports de plein air, le médical, l'armée, les forces spéciales, l'emballage et l'industrie.

100% MADE IN ITALY

IP67 RATING

N CAGE NATO AN908

MIL SPECS STANAG 4280
DEF STAN 81-41

ATA 300





Valigie ermetiche / Watertight cases / Wasserdichte Koffer / Valises étanches



- | | | |
|---|----|--|
| Guarnizione ermetica | 1 | <i>Watertight seal around lid</i> |
| Valvola automatica di pressurizzazione | 2 | <i>Automatic pressure release valve</i> |
| Chiusure di sicurezza a doppio step per facilitare l'apertura | 3 | <i>Easy to open double throw latches</i> |
| Manico morbido ad alta ergonomia | 4 | <i>Load tested soft grip handle</i> |
| Doppia predisposizione lucchetto | 5 | <i>Holes for double padlocking</i> |
| Predisposizione cintura a tracolla | 6 | <i>Holes for shoulder strap</i> |
| Sistema di impilabilità | 7 | <i>Stackable interlocking system</i> |
| Pareti molto spesse per garantire la resistenza agli urti | 8 | <i>Thick body material</i> |
| Punti di fissaggio per varie applicazioni | 9 | <i>Extra fixing points</i> |
| Cerniera lungo tutto il profilo della valigia | 10 | <i>Fully length hinges</i> |
| Perni in nylon, nessun problema di corrosione | 11 | <i>Nylon pins, corrosion free</i> |
| Spugne cubettate nel fondo e bugnate nel coperchio di serie* | 12 | <i>Cubed foams in the bottom and convoluted foam in the lid (available as standard)*</i> |
| Coperchio serigrafabile | 13 | <i>Screen printing space on the lid</i> |
| Predisposizione per etichetta resinata | 14 | <i>Rectangular resin label space on the lid</i> |

*Spugne sagomate disponibili su richiesta

* Custom foam available upon request

- | | | |
|---|----|--|
| <i>Wasserfeste Dichtung im Kofferdeckel</i> | 1 | <i>Joint d'étanchéité du couvercle</i> |
| <i>Automatisches Druckausgleichsventil</i> | 2 | <i>Valve d'équilibrage automatique de pression</i> |
| <i>Einfach zu öffnende zweistufige Schnappverschlüsse</i> | 3 | <i>Système d'ouverture facile à double levier</i> |
| <i>Belastbarer weicher Haltegriff für hohen Tragekomfort</i> | 4 | <i>Poignée résistante assurant une prise confortable</i> |
| <i>Zwei Lochungen für Vorhängeschlösser</i> | 5 | <i>Double perçage pour cadenas</i> |
| <i>Befestigungsösen, um einen Tragegurt anzubringen</i> | 6 | <i>Points d'accroche pour bandoulière selon modèles</i> |
| <i>Stapelbar</i> | 7 | <i>Rainures permettant l'empilage des valises</i> |
| <i>Stoßfestigkeit durch extra starke Wandung</i> | 8 | <i>Parois épaisses</i> |
| <i>Fixierpunkte für Zwischenplatten</i> | 9 | <i>Points de fixation supplémentaires pour différentes applications</i> |
| <i>Stabiles Scharnier über die komplette Länge</i> | 10 | <i>Charnière sur toute la longueur</i> |
| <i>Stifte aus Nylon® garantieren Korrosionsschutz</i> | 11 | <i>Axes en nylon® résistant à la corrosion</i> |
| <i>Rasterschaum im Boden und Noppenschaum im Deckel standardmäßig erhältlich*</i> | 12 | <i>Version standard avec mousse prédécoupée dans le fond et mousse alvéolée dans le couvercle*</i> |
| <i>Deckel bedruckbar</i> | 13 | <i>Emplacement pour sérigraphie sur le couvercle</i> |
| <i>Aussparung für Aufkleber</i> | 14 | <i>Emplacement rectangulaire pour étiquette</i> |

*Kundenspezifische Schaumstoffeinlagen auf Anfrage

*Autres mousses disponibles sur demande

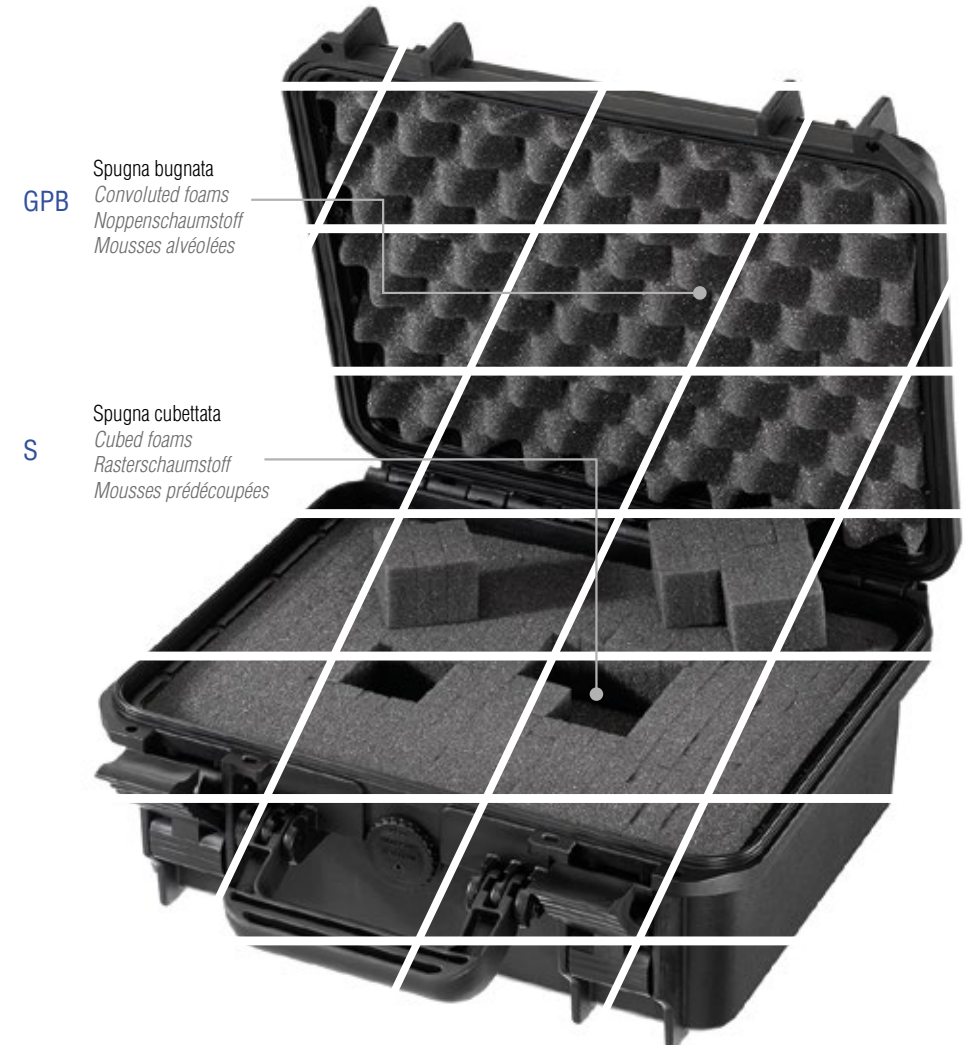

Valigie ermetiche / Watertight cases / Wasserdichte Koffer / Valises étanches



MAX235 H105

 235 x 180 x H106 mm
9.25 x 7.08 x H4.17 inch

 25 + 81 mm
0.98 + 3.19 inch.

 0,82 kg / 1.80 lb





 Spugne cubettate / Cubed foams / Rasterschaumstoff / Mousse
prédécoupées



MAX235 H155

 235 x 180 x H156 mm
9.25 x 7.08 x H6.14 inch.

 25 + 131 mm
0.98 + 5.16 inch.

 0,96 kg / 2.11 lb



 Spugne cubettate / Cubed foams / Rasterschaumstoff / Mousse
prédécoupées



MAX300

 300 x 225 x H132 mm
11.81 x 8.86 x H5.20 inch.

 33 + 99 mm
1.30 + 3.90 inch.

 1,62 kg / 3.57 lb



 Spugne cubettate / Cubed foams / Rasterschaumstoff / Mousse
prédécoupées



MAX380 H115

 380 x 270 x H115 mm
14.96 x 10.62 x H4.52 inch.

 36 + 79 mm
1.42 + 3.11 inch.

 2,10 kg / 4.63 lb



 Spugne cubettate / Cubed foams / Rasterschaumstoff / Mousses prédécoupées

MAX380 H160

 380 x 270 x H160 mm
14.96 x 10.62 x H6.29 inch.

 36 + 124 mm
1.42 + 4.90 inch.

 2,455 kg / 5.41 lb



 Spugne cubettate / Cubed foams / Rasterschaumstoff / Mousses prédécoupées

MAX430

 426 x 290 x H159 mm
16.77 x 11.42 x H6.26 inch.

 45 + 114 mm
1.77 + 4.49 inch.

 2,76 kg / 6.08 lb



 Spugne cubettate / Cubed foams / Rasterschaumstoff / Mousses prédécoupées



Valigie ermetiche / Watertight cases / Wasserdichte Koffer / Valises étanches



MAX465-H125

 465 x 335 x H125 mm
18.31 x 13.19 x H4.92 inch.

 40 + 85 mm
1.57 + 3.35 inch.

 2,62 kg / 5.77 lb





 Spugne cubettate / Cubed foams / Rasterschaumstoff / Moussees prédécoupées



MAX465-H220

 465 x 335 x H220 mm
18.31 x 13.19 x H8.66 inch.

 40 + 180 mm
1.57 + 7.09 inch.

 3,44 kg / 7.58 lb



 Spugne cubettate / Cubed foams / Rasterschaumstoff / Moussees prédécoupées



MAX465-H220 TR

 465 x 335 x H220 mm
18.31 x 13.19 x H8.66 inch.

 40 + 180 mm
1.57 + 7.09 inch.

 4,46 kg / 9.83 lb



 Spugne cubettate / Cubed foams / Rasterschaumstoff / Moussees prédécoupées



Retro maniglia
telescopica a scomparsa
Extendable handle
Ausziehbarer Griff
Poignée télescopique

MAX505

 500 x 350 x H194 mm
19.69 x 13.78 x H7.64 inch.

 58 + 136 mm
2.28 + 5.36 inch.

 3,9 kg / 8.59 lb



 Spugne cubettate / Cubed foams / Rasterschaumstoff /
Mousses prédécoupées



MAX505 H280

 500 x 350 x H280 mm
19.69 x 13.78 x H11 inch.

 58 + 222 mm
2.28 + 8.74 inch.

 5,1 kg / 11.24 lb



 Spugne cubettate / Cubed foams / Rasterschaumstoff /
Mousses prédécoupées





MAX505 TR



Retro maniglia
telescopica a scomparsa
Extendable handle
Ausziehbarer Griff
Poignée télescopique

 500 x 350 x H194 mm
19.69 x 13.78 x H7.64 inch.

 58 + 136 mm
2.28 + 5.36 inch.

 5,04 kg / 11.11 lb



 Spugne cubettate / Cubed foams / Rasterschaumstoff /
Mousses prédécoupées



MAX505 H280 TR



Retro maniglia
telescopica a scomparsa
Extendable handle
Ausziehbarer Griff
Poignée télescopique

 500 x 350 x H280 mm
19.69 x 13.78 x H11 inch.

 58 + 222 mm
2.28 + 8.74 inch.

 6,1 kg / 13.44 lb



 Spugne cubettate / Cubed foams / Rasterschaumstoff /
Mousses prédécoupées





Valigie ermetiche / Watertight cases / Wasserdichte Koffer / Valises étanches



MAX520

 520 x 290 x H200 mm
20.47 x 11.42 x H7.87 inch.

 45 + 155 mm
1.77 + 6.10 inch.

 3,58 kg / 7.89 lb



 Spugne cubettate / Cubed foams / Rasterschaumstoff / Mousses
prédecoupées

 Ruote con assale in acciaio inox
Wheels with stainless steel pin
Rollen mit Achsen aus rostfreiem Stahl
Roulettes avec axe en acier inoxydable

 Retro maniglia
telescopica a scomparsa
Extendable handle
Ausziehbarer Griff
Poignée télescopique



MAX520 TR

 520 x 290 x H200 mm
20.47x 11.42 x H7.87 inch

 45 + 155 mm
1.77 + 6.10 inch.

 5,06 kg / 11.15 lb



 Spugne cubettate / Cubed foams / Rasterschaumstoff / Mousses
prédecoupées

975 mm
38.39 inch



MAX540 H190



Maniglia laterale su entrambi i lati
Side handles
Seitliche Griffe auf beiden Seiten
Poignées latérales rabattables

 538 x 405 x H190 mm
21.18 x 15.94 x H7.48 inch.

 50 + 140 mm
1.97 + 5.51 inch.

 4,76 kg / 10.49 lb



 Spugne cubettate / *Cubed foams / Rasterschaumstoff / Mousses prédécoupées*





MAX540 H245



Maniglia laterale su entrambi i lati
Side handles
Seitliche Griffe auf beiden Seiten
Poignées latérales rabattables

 538 x 405 x H245 mm
21.18 x 15.94 x H9.64 inch.

 50 + 195 mm
1.97 + 7.68 inch.

 5,30 kg / 11.68 lb



 Spugne cubettate / *Cubed foams / Rasterschaumstoff / Mousses prédécoupées*



MAX540 H190 TR



Retro maniglia
telescopica a scomparsa
Extendable handle
Ausziehbarer Griff
Poignée télescopique

 538 x 405 x H190 mm
21.18 x 15.94 x H7.48 inch.

 50 + 140 mm
1.97 + 5.51 inch.

 6,28 kg / 13.84 lb



 Spugne cubettate / *Cubed foams / Rasterschaumstoff / Mousses prédécoupées*



980 mm
38.58 inch

MAX540 H245 TR



Retro maniglia
telescopica a scomparsa
Extendable handle
Ausziehbarer Griff
Poignée télescopique

 538 x 405 x H245 mm
21.18 x 15.94 x H9.64 inch.

 50 + 195 mm
1.97 + 7.68 inch.

 6,84 kg / 15.07 lb



 Spugne cubettate / *Cubed foams / Rasterschaumstoff / Mousses prédécoupées*



980 mm
38.58 inch

Valigie ermetiche / Watertight cases / Wasserdichte Koffer / Valises étanches

MAX620 H250



Maniglia laterale su entrambi i lati
Side handles
Seitliche Griffe auf beiden Seiten
Poignées latérales rabattables

620 x 460 x 250 mm
24.40 x 18.11 x 9.84 inch.

60 + 190 mm
2.36 + 7.48 inch.

6,98 kg / 15.38 lb



Spugne cubettate / *Cubed foams* /
Rasterschaumstoff / Mousses prédécoupées



MAX620 H340



Maniglia laterale su entrambi i lati
Side handles
Seitliche Griffe auf beiden Seiten
Poignées latérales rabattables

620 x 460 x 340 mm
24.41 x 18.11 x 13.38 inch.

60 + 280 mm
2.36 + 11.02 inch.

8,08 kg / 17.81 lb



Spugne cubettate / *Cubed foams* /
Rasterschaumstoff / Mousses prédécoupées



Retro maniglia
telescopica a scomparsa
Extendable handle
Ausziehbarer Griff
Poignée télescopique

MAX620 H250 TR

620 x 460 x 250 mm
24.40 x 18.11 x 9.84 inch.

60 + 190 mm
2.36 + 7.48 inch.

8,5 kg / 18.73 lb



Spugne cubettate / *Cubed foams* /
Rasterschaumstoff / Mousses prédécoupées



105 cm
41.34 inch

MAX620 H340 TR



Retro maniglia
telescopica a scomparsa
Extendable handle
Ausziehbarer Griff
Poignée télescopique

620 x 460 x 340 mm
24.41 x 18.11 x 13.38 inch.

60 + 280 mm
2.36 + 11.02 inch.

9,6 kg / 21.16 lb



Spugne cubettate / *Cubed foams* /
Rasterschaumstoff / Mousses prédécoupées



MAX750 H280 - MAX750 H400 - MAX820

Ruote con assale in acciaio inox
 Wheels with stainless steel pin
 Rollen mit Achsen aus rostfreiem Stahl
 Roulettes avec axe en acier inoxydable





MAX750 H280 - MAX750 H400 - MAX820

Maniglia laterale su entrambi i lati + maniglione per trasporto
 Side handles + large fold down handle
 Seitliche Griffe auf beiden Seiten + spezieller umklappbarer Transportgriff
 Poignées latérales rabattables + 1 large poignée rabattable pour le transport



MAX750 H280

 750 x 480 x H280 mm
 29.52 x 18.90 x H11 inch.

 60 + 220 mm
 2.36 + 8.66 inch.

 10,2 kg / 22.48 lb



 Spugne cubettate / Cubed foams / Rasterschaumstoff /
 Mousses prédécoupées

MAX750 H400

 750 x 480 x H400 mm
 29.52 x 18.90 x H15.75 inch.

 60 + 340 mm
 2.36 + 13.38 inch.

 12,1 kg / 26.67 lb



 Spugne cubettate / Cubed foams / Rasterschaumstoff /
 Mousses prédécoupées

MAX820

 820 x 600 x H450 mm
 32.28 x 23.62 x H17.71 inch.

 70 + 380 mm
 2.75 + 14.96 inch.

 21 kg / 46.29 lb



 Spugne cubettate / Cubed foams / Rasterschaumstoff /
 Mousses prédécoupées

MAX800

 800 x 370 x H140 mm
31,49 x 14,57 x H5,51 inch.

 45 + 95 mm
1,77 + 3,74 inch.

 6,2 kg / 13,66 lb



Spugne cubettate (S) / Cubed foams (S) / Rasterschaumstoff (S) /
Mousses prédécoupées (S)



Spugne bugnate (GPB) / Convoluted foams (GPB) /
Noppenschaumstoff (GPB) / Mousses alvéolées (GPB)

Spugne alta densità (SAD) / High density foam (SAD) /
Hartschaumstoff (SAD) / Mousse haute densité (SAD)



Nuova chiusura rotante
New revolving lock
Neuer Drehverschluss
Nouveau verrouillage



MAX1100

 1100 x 370 x H140 mm
43,30 x 14,57 x H5,51 inch.

 45 + 95 mm
1,77 + 3,74 inch.

 7,86 kg / 17,32 lb



Spugne cubettate (S) / Cubed foams (S) / Rasterschaumstoff (S) /
Mousses prédécoupées (S)



Spugne bugnate (GPB) / Convoluted foams (GPB) /
Noppenschaumstoff (GPB) / Mousses alvéolées (GPB)

Spugne alta densità (SAD) / High density foam (SAD) /
Hartschaumstoff (SAD) / Mousse haute densité (SAD)



Valigie ermetiche / Watertight cases / Wasserdichte Koffer / Valises étanches

Valigie con divisorie imbottite / Padded divider cases / Koffer mit gepolsterten Unterteilungen / Valises avec Kit de cloisons mobiles



Spugna bugnata
Convuluted foam
Noppenschaum
Mousse alvéolée



Organizer per coperchio
Lid organizer
Mehrzwecktasche
Rangement multi-usage

CAM

Disponibile per:
Available on:

MAX300 - MAX380H160
MAX430 - MAX505
MAX520 - MAX540H245

CAM ORG

Disponibile per:
Available on:

MAX380H160 - MAX430
MAX520 - MAX540H245

Trolley disponibile per:

Extendable handle available on:
Ausziehbarer Griff vorhanden an:
Poignée télescopique disponible sur:

MAX505 CAM - MAX520 CAM
MAX540H245 CAM - MAX520 CAM ORG
MAX540H245 CAM ORG





MAX[®] GRIP SERIES

Le scatole MAX Grip sono impermeabili e resistenti ad urti e polveri. Certificate IP67 e dotate di una valvola automatica di pressurizzazione, queste scatole si adattano ad ogni tipo d'utilizzo ed d'applicazione, fornendo una protezione superiore dagli agenti atmosferici. Sono disponibili in differenti misure e configurazioni: vuote, con scomparti fissi e con scomparti mobili.

Max Grip line, waterproof and dustproof utility box. They are IP67 certified and equipped with an automatic pressure release valve. These boxes are suitable for any type of use or application, ensuring superior protection from impacts and elements. Available in different sizes and versions: empty and with compartments.



MAX001V

 157 x 82 x H41 mm
6.18 x 3.22 x H1.61 inch.

 12 + 29 mm
0.47 + 1.14 inch.

 0,14 kg / 0.30 lb





 Spugne cubettate (S) / Cubed foams (S) / Rasterschaumstoff (S) / Moussees prédécoupées (S)
 Spugne bugnate (GPB) / Convoluted foams (GPB) / Noppenschaumstoff (GPB) / Moussees alvéolées (GPB)





MAX002V

 212 x 140 x H47 mm
8.34 x 5.51 x H1.85 inch.

 14 + 33 mm
0.55 + 1.33 inch.

 0,26 kg / 0.57 lb



 Spugne cubettate (S) / Cubed foams (S) / Rasterschaumstoff (S) / Moussees prédécoupées (S)
 Spugne bugnate (GPB) / Convoluted foams (GPB) / Noppenschaumstoff (GPB) / Moussees alvéolées (GPB)



MAX001S



MAX001VT



Vuota
Empty
Leer
Vide

MAX001GPB



MAX001T



4 Scomparti
4 Compartments
4 Unterteilungen
4 Compartments

MAX002S



MAX002T



3-15 Scomparti mobili
3-15 Adjustable compartments
3-15 Verstellbare Unterteilungen
3-15 Compartments interchangeable

MAX002GPB





MAX GRIP ist eine Reihe von wasser- und staubdichten Boxen. Sie haben eine IP67-Zertifizierung und sind mit einem automatischen Druckausgleichsventil versehen. Diese Boxen sind für alle Zwecke einsetzbar und garantieren besonderen Schutz gegen Kräfteinwirkung und andere Umwelteinflüsse. Sie sind in unterschiedlichen Größen und Versionen erhältlich: leer oder mit Unterteilungen.

La gamme de boîtes MAXgrip, étanche à l'eau et aux poussières, a été créée pour les plus exigeants. Certifiées IP67 et équipées d'une valve d'équilibrage automatique de pression d'air, ces boîtes garantissent une protection maximale contre l'eau, la poussière et les chocs, les rendant adaptées dans de multiples secteurs et applications. Disponibles dans différentes tailles et versions : vides, avec compartiments fixes, avec compartiments modulables.



MAX003V

 316 x 195 x H53 mm
12.44 x 7.67 x H2.08 inch.

 16 + 37 mm
0.63 + 1.46 inch.

 0,48 kg / 1.05 lb



 Spugne cubettate (S) / Cubed foams (S) / Rasterschaumstoff (S) / Moussees prédécoupées (S)
 Spugne bugnate (GPB) / Convoluted foams (GPB) / Noppenschaumstoff (GPB) / Moussees alvéolées (GPB)



MAX003S



MAX003GPB





MAX003T



3-15 scomparti mobili
3-15 adjustable compartments
3-15 Verstellbare Unterteilungen
3-15 compartments interchangeable

MAX004V

 316 x 195 x H81 mm
12.44 x 7.67 x H3.18 inch.

 16 + 65 mm
0.63 + 2.55 inch.

 0,54 kg / 1.19 lb



 Spugne cubettate (S) / Cubed foams (S) / Rasterschaumstoff (S) / Moussees prédécoupées (S)



MAX004S



MAX004T



3 scomparti
3 compartments
3 Unterteilungen
3 Compartiments

Accessori e personalizzazioni / Accessories and customizations /
Zubehör und kundenspezifische Anpassungen / Accessoires et personnalisations

PANNELLI
PANELS
TRENNPLATTEN
PANNEAUX



TASCHE
LID ORGANIZER
MEHRZWECKTASCHEN
PORTE-DOCUMENTS ET RANGEMENT MULTI-USAGE



DIVISORIE IMBOTTITE
PADDED DIVIDERS
GEPOLSTERTE UNTERTEILUNGEN
KIT DE CLOISONS MOBILES



SERIGRAFIA
SCREEN PRINTING
SIEBDRUCK
SÉRIGRAPHIE



ETICHETTA RESINATA
RESIN LABEL
(DOMINIATE) AUFKLEBER
ETIQUETTE EN RÉSINE



SPUGNE CUBETTATE
CUBED FOAMS
RASTERSCHAUMSTOFFE
MOUSSE PRÉDÉCOUPÉE



SPUGNE PERSONALIZZATE
CUSTOM FOAM INLAY
KUNDENSPEZIFISCHE SCHAUMSTOFFEINLAGEN
MOUSSE DÉCOUPÉE PERSONNALISÉE



TRAMAX
Tracolla imbottita
Padded shoulder strap
Gepolsterter Tragegurt
Bandoulière renforcée



MAXPACK
Zaino
Backpack
Rucksack-System
Bretelle



MAXRACK
Cornice 19" per unità rack
19" rack mounting frame
19-Zoll-Rack-Einbaurahmen
Cadre de montage pour rack 19"



ARTICOLO ITEM	DIMENSIONI ESTERNE EXTERNAL DIMENSIONS	DIMENSIONI INTERNE INTERNAL DIMENSIONS	COPERCHIO LID	FONDO BOTTOM	PESO WEIGHT	PESO con spugne WEIGHT w.foam	CAPACITÀ CAPACITY	ACCESSORI ACCESSORIES	COLORI COLOURS
								TOOL STORAGE SYSTEM PADDED DIVIDERS LID ORGANIZER PANELS PADDED SHOULDER STRAP	BACKPACK
MAX001	175 x 115 x H47 mm / 6.88 x 4.52 x H1.85 inch	157 x 82 x H41 mm / 6.18 x 3.22 x H1.61 inch	12 mm / 0.47 inch	29 mm / 1.14 inch	0,14 kg	0,15 kg	0,527 lt		
MAX002	230 x 175 x H53 mm / 9.05 x 6.88 x H2.08 inch	212 x 140 x H47 mm / 8.34 x 5.51 x H1.85 inch	14 mm / 0.55 inch	33 mm / 1.33 inch	0,26 kg	0,28 kg	1,39 lt		
MAX003	350 x 230 x H59 mm / 13.77 x 9.05 x H2.32 inch	316 x 195 x H53 mm / 12.44 x 7.67 x H2.08 inch	16 mm / 0.63 inch	37 mm / 1.46 inch	0,48 kg	0,52 kg	3,26 lt		
MAX004	350 x 230 x H86 mm / 13.77 x 9.05 x H3.38 inch	316 x 195 x H81 mm / 12.44 x 7.67 x H3.18 inch	16 mm / 0.63 inch	65 mm / 2.55 inch	0,54 kg	0,62 kg	4,99 lt		
MAX235H105	258 x 243 x H117,5 mm / 10.16 x 9.56 x H4.62 inch	235 x 180 x H106 mm / 9.25 x 7.08 x H4.17 inch	25 mm / 0.98 inch	81 mm / 3.19 inch	0,82 kg	0,88 kg	4,48 lt		
MAX235H155	258 x 243 x H167.5 mm / 10.16 x 9.56 x H6.59 inch	235 x 180 x H156 mm / 9.25 x 7.08 x H6.14 inch	25 mm / 0.98 inch	131 mm / 5.16 inch	0,96 kg	1,06 kg	6,60 lt		
MAX300	336 x 300 x H148 mm / 13.23 x 11.81 x H5.83 inch	300 x 225 x H132 mm / 11.81 x 8.86 x H5.20 inch	33 mm / 1.30 inch	99 mm / 3.90 inch	1,62 kg	1,76 kg	8,91 lt	X X	
MAX380H115	414 x 345 x H129 mm / 16.30 x 13.58 x H5.08 inch	380 x 270 x H115 mm / 14.96 x 10.62 x H4.52 inch	36 mm / 1.42 inch	79 mm / 3.11 inch	2,10 kg	2,35 kg	11,8 lt	X X	
MAX380H160	414 x 345 x H174 mm / 16.29 x 13.58 x H6.85 inch	380 x 270 x H160 mm / 14.96 x 10.62 x H6.29 inch	36 mm / 1.42 inch	124 mm / 4.90 inch	2,455 kg	2,755 kg	16,4 lt	X X X X	
MAX430	464 x 366 x H176 mm / 18.27 x 14.41 x H6.93 inch	426 x 290 x H159 mm / 16.77 x 11.42 x H6.26 inch	45 mm / 1.77 inch	114 mm / 4.49 inch	2,76 kg	3,04 kg	19,64 lt	X X X X	
MAX465H125	502 x 415 x H141 mm / 19.76 x 16.34 x H5.55 inch	465 x 335 x H125 mm / 18.31 x 13.19 x H4.92 inch	40 mm / 1.57 inch	85 mm / 3.35 inch	2,62 kg	2,92 kg	19,47 lt	X X X	
MAX465H220	502 x 415 x H246 mm / 19.76 x 16.34 x H9.69 inch	465 x 335 x H220mm / 18.31 x 13.19 x H8.66 inch	40 mm / 1.57 inch	180 mm / 7.09 inch	3,44 kg	3,98 kg	34,27 lt	X X X	
MAX465H220TR	502 x 422 x H 267 mm / 19.76 x 16.61 x H 10.51 inch	465 x 335 x H 220 mm / 18.31 x 13.19 x 8.66 inch	40 mm / 1.57 inch	180 mm / 7.09 inch	4,46 kg	5 kg	34,27 lt	X X X	
MAX505	555 x 428 x H211 mm / 21.85 x 16.85 x H8.31 inch	500 x 350 x H194 mm / 19.69 x 13.78 x H7.64 inch	58 mm / 2.28 inch	136 mm / 5.36 inch	3,9 kg	4,38 kg	33,95 lt	X X X X	
MAX505TR	555 x 445 x H258 mm / 21.85 x 17.52 x H10.16 inch	500 x 350 x H194 mm / 19.69 x 13.78 x H7.64 inch	58 mm / 2.28 inch	136 mm / 5.36 inch	5,04 kg	5,54 kg	33,95 lt	X X X X	
MAX505H280	555 x 428 x H306 mm / 21.85 x 16.85 x H12.04 inch	500 x 350 x H280 mm / 19.69 x 13.78 x H11 inch	58 mm / 2.28 inch	222 mm / 8.74 inch	5,1 kg	6,03 kg	49 lt	X X	
MAX505H280TR	555 x 437 x H326 mm / 21.85 x 17.20 x H12.84 inch	500 x 350 x H280 mm / 19.69 x 13.78 x H11 inch	58 mm / 2.28 inch	222 mm / 8.74 inch	6,1 kg	7,03 kg	49 lt	X X	
MAX520	574 x 361 x H225 mm / 22.60 x 14.21 x H8.86 inch	520 x 290 x H200 mm / 20.47 x 11.42 x H7.87 inch	45 mm / 1.77 inch	155 mm / 6.10 inch	3,58 kg	4,02 kg	30,16 lt	X X X	
MAX520TR	585 x 361 x H238 mm / 23.03 x 14.21 x H9.37 inch	520 x 290 x H200 mm / 20.47 x 11.42 x H7.87 inch	45 mm / 1.77 inch	155 mm / 6.10 inch	5,06 kg	5,50 kg	30,16 lt	X X X X X	
MAX540H190	594 x 473 x H215 mm / 23.39 x 18.62 x H8.46 inch	538 x 405 x H190 mm / 21.18 x 15.94 x H7.48 inch	50 mm / 1.97 inch	140 mm / 5.51 inch	4,76 kg	5,4 kg	41,40 lt	X	
MAX540H190TR	604 x 473 x H225 mm / 23.78 x 18.62 x H8.86 inch	538 x 405 x H190 mm / 21.18 x 15.94 x H7.48 inch	50 mm / 1.97 inch	140 mm / 5.51 inch	6,28 kg	6,94 kg	41,40 lt	X X X	
MAX540H245	594 x 473 x H270 mm / 23.39 x 18.62 x H10.63 inch	538 x 405 x H245 mm / 21.18 x 15.94 x H9.64 inch	50 mm / 1.97 inch	195 mm / 7.68 inch	5,3 kg	6,16 kg	53,38 lt	X X	
MAX540H245TR	604 x 473 x H283 mm / 23.78 x 18.62 x H11.14 inch	538 x 405 x H245 mm / 21.18 x 15.94 x H9.64 inch	50 mm / 1.97 inch	195 mm / 7.68 inch	6,84 kg	7,7 kg	53,38 lt	X X X X	
MAX620H250	687 x 528 x H276 mm / 27.05 x 20.79 x H10.86 inch	620 x 460 x H250 mm / 24.40 x 18.11 x H9.84 inch	60 mm / 2.36 inch	190 mm / 7.48 inch	6,98 kg	8,14 kg	71,30 lt		
MAX620H250TR	687 x 528 x H286 mm / 27.05 x 20.79 x H11.26 inch	620 x 460 x H250 mm / 24.40 x 18.11 x H9.84 inch	60 mm / 2.36 inch	190 mm / 7.48 inch	8,5 kg	9,7 kg	71,30 lt		
MAX620H340	687 x 528 x H366 mm / 27.05 x 20.79 x H14.41 inch	620 x 460 x H340 mm / 24.41 x 18.11 x H13.38 inch	60 mm / 2.36 inch	280 mm / 11.02 inch	8,08 kg	9,6 kg	96,96 lt		
MAX620H340TR	687 x 528 x H376 mm / 27.05 x 20.79 x H14.80 inch	620 x 460 x H340 mm / 24.41 x 18.11 x H13.38 inch	60 mm / 2.36 inch	280 mm / 11.02 inch	9,6 kg	11,12 kg	96,96 lt		
MAX750H280	816 x 540 x H306 mm / 32.12 x 21.26 x H12.04 inch	750 x 480 x H280 mm / 29.52 x 18.90 x H11 inch	60 mm / 2.36 inch	220 mm / 8.66 inch	10,2 kg	11,8 kg	100,80 lt		
MAX750H400	816 x 540 x H426 mm / 32.12 x 21.26 x H16.77 inch	750 x 480 x H400 mm / 29.52 x 18.90 x H15.75 inch	60 mm / 2.36 inch	340 mm / 13.38 inch	12,1 kg	13,7 kg	144 lt		
MAX820	880 x 660 x H483 mm / 34.64 x 25.98 x H19.01 inch	820 x 600 x H450 mm / 32.28 x 23.62 x H17.71 inch	70 mm / 2.75 inch	380 mm / 14.96 inch	16 kg	21 kg	220 lt		
MAX800	850 x 440 x H158 mm / 33.46 x 17.32 x H6.22 inch	800 x 370 x H140 mm / 31.49 x 14.57 x H5.51 inch	45 mm / 1.77 inch	95 mm / 3.74 inch	6,2 kg	7,06 kg	41,44 lt		
MAX1100	1177 x 450 x H158 mm / 46.34 x 17.72 x H6.22 inch	1100 x 370 x H140 mm / 43.30 x 14.57 x H5.51 inch	45 mm / 1.77 inch	95 mm / 3.74 inch	7,86 kg	8,72 kg	56,98 lt		

Procace Series

Resistente struttura in polipropilene, doppie maniglie basculanti salva-spazio, cerniera in metallo e serrature professionali. Le valigie della linea Procace sono solide e compatte. Studiate per trasportare e proteggere al meglio qualsiasi componente sono caratterizzate da una sagoma interna ben squadrata, ideale per la personalizzazione degli interni.

Durable polypropylene structure, space efficient double handles, metal hinge and professional clips. The suitcases from the Procace series are durable and compact. Developed to safely store and transport your items, they are characterized by a nicely squared inner shape, which makes it very easy to customize.

Ein robuster Körper aus Polypropylen, Doppelgriffe, Metallsplinte und professionelle Verschlüsse zeichnen diese Produkte aus. Die Koffer der Reihe "Procace" sind haltbar und kompakt. Sie wurde entwickelt, um den zu transportierenden Inhalt zu schützen. Durch die rechteckige Form können Sie die Einlagen optimal anpassen.

Structure en polypropylène robuste, doubles-poignées compactes, charnière en métal et fermoirs professionnels. Les mallettes de la série Procace sont durables et compactes. Développées pour stocker et transporter vos articles en toute sécurité, elles se caractérisent par une forme intérieure bien rectangulaire, ce qui facilite grandement les personnalisations.

DIMENSIONI INTERNE INTERNAL DIMENSIONS	LUNGHEZZA LENGTH	LARGHEZZA WIDTH	ALTEZZA FONDO BOTTOM HEIGHT	ALTEZZA COPERCHIO LID HEIGHT	COLORI DISPONIBILI COLOURS AVAILABLE	COLORI ACCESSORI CLIP/HANDLE COLOURS	
						Standard	Non standard
Art. 170/34H96	324* (12.76)	251* (9.88)	43.5* (1.71)	43.5* (1.71)	●	●	● ● ●
Art. 170/34H128	320* (12.60)	247* (9.72)	75* (2.95)	43.5* (1.71)	●	●	● ● ●
Art. 170/34H160	320* (12.60)	247* (9.72)	75* (2.95)	75* (2.95)	●	●	● ● ●
Art. 170/43H122	406* (15.98)	290* (11.42)	55* (2.16)	55* (2.16)	●	●	● ● ●
Art. 170/43H156	402* (15.83)	287* (11.30)	89.5* (3.52)	55* (2.16)	●	●	● ● ●
Art. 170/43H190	402* (15.83)	287* (11.30)	89.5* (3.52)	89.5* (3.52)	●	●	● ● ●
Art. 170/48H132	460* (18.11)	325* (12.79)	60* (2.36)	60* (2.36)	● ●	●	● ● ●
Art. 170/48H160	460* (18.11)	325* (12.79)	85* (3.35)	60* (2.36)	● ●	●	● ● ●
Art. 170/48H184	460* (18.11)	325* (12.79)	85* (3.35)	85* (3.35)	● ●	●	● ● ●
Art. 170/60H144	575* (22.64)	355* (13.98)	66* (2.60)	66* (2.60)	●	●	● ● ●
Art. 170/60H184	575* (22.64)	355* (13.98)	106* (4.17)	66* (2.60)	●	●	● ● ●
Art. 170/60H224	575* (22.64)	355* (13.98)	106* (4.17)	106* (4.17)	●	●	● ● ●
Art. 170/48H184PU	460* (18.11)	325* (12.79)	85* (3.35)	85* (3.35)	●	●	● ● ●

*= mm. ()= inch.



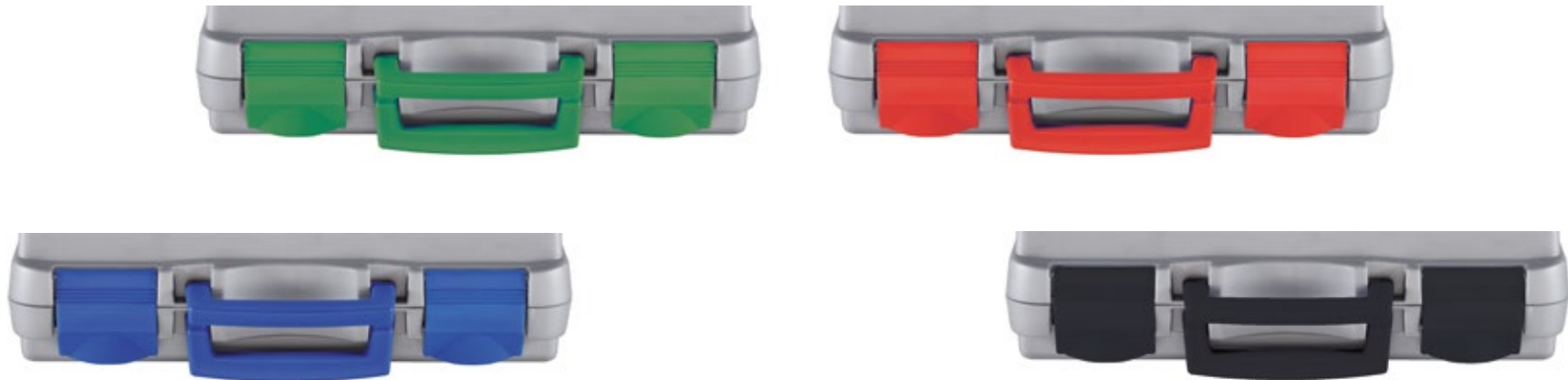

4 Colori, serrature e manici
Clip and handle colours
Farben, Verschlüsse und Griffe
Couleurs, serrures et poignées

Interni in spugna fustellata
Customized foam inlay
Kundenspezifische Schaumstoffeinlagen
Mousse découpée personnalisée



Serigrafia
Screen printing
Siebdruck
Sérigraphie



Interni in termoformato
Customized thermoformed inlay
Kundenspezifisches thermogeformtes Inlay
Incrustation thermoformée sur mesure



Spugna bugnata
Convuluted foam
Noppenschaumstoff
Mousses alvéolées

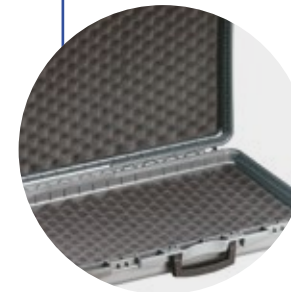

Advanced Series

Linee morbide ed un design innovativo: ecco la linea Advanced. Valigette in polipropilene resistenti ed affidabili, create per proteggere e trasportare i tuoi oggetti. Ampia possibilità di personalizzazione.

Soft lines and an innovative design: here's the Advanced line. Durable and reliable polypropylene cases, designed to protect and transport your items. Wide possibility of internal customization.

Unsere Reihe "Advanced" zeichnet sich durch sanfte Konturen und einem innovativen Design aus. Haltbare, stabile Polypropylenkoffer, die dazu entwickelt wurden, um den Inhalt gut geschützt zu transportieren. Es bestehen diverse Möglichkeiten, diese Koffer an Kundenwünsche anzupassen (Schaumstoffeinlagen, Aufkleber, Siebdruck und verschiedene Farbkombinationen)

Des lignes douces et un design innovant: voici la gamme Advanced. Des mallettes en polypropylène durables et fiables, conçues pour protéger et transporter vos objets. Larges possibilités de personnalisations internes (avec des mousses) et externes, combinant des fermoirs de différentes couleurs, l'application étiquettes et la réalisation de sérigraphies.



DIMENSIONI INTERNE INTERNAL DIMENSIONS	LUNGHEZZA LENGTH	LARGHEZZA WIDTH	ALTEZZA FONDO BOTTOM HEIGHT	ALTEZZA COPERCHIO LID HEIGHT	LARGHEZZA MIN. INTERNA MIN. INTERNAL WIDTH	COLORI DISPONIBILI COLOURS AVAILABLE	COLORI ACCESSORI CLIP/HANDLE COLOURS	
							Standard	Non standard
Art. 170/25 Imp Art. 170/25T Imp	235* (9.25)	185* (7.28)	30* (1.18)	13* (0.51)	163* (6.42)	● ● ● ●		
Art. 170/26H44	248* (9.76)	178* (7.01)	19.5* (0.77)	19.5* (0.77)	160* (6.30)	●	●	● ● ●
Art. 170/26H60	247* (9.72)	177* (6.95)	35.5* (1.40)	19.5* (0.77)	159* (6.26)	●	●	● ● ●
Art. 170/26H76	247* (9.72)	177* (6.95)	35.5* (1.40)	35.5* (1.40)	159* (6.26)	● ●	●	● ● ●
Art. 170/28 Art. 170/28T	272* (10.71)	215* (8.47)	51* (2.01)	22* (0.87)	190* (7.48)	● ●		
Art. 170/30N	312* (12.28)	250* (9.84)	63* (2.48)	52* (2.04)	225* (8.86)	● ● ●		
Art. 170/33	332* (12.84)	235* (9.25)	39* (1.54)	39* (1.54)	228* (8.97)	● ●	●	● ● ●
Art. 170/37	363* (14.30)	256* (10.08)	83* (3.27)	32* (1.26)	244* (9.60)	● ●	●	● ● ●
Art. 170/37T	363* (14.30)	256* (10.08)	83* (3.27)	32* (1.26)	244* (9.60)	●	●	
Art. 170/38N	385* (15.16)	260* (10.24)	55* (2.17)	43* (1.69)	235* (9.25)	● ● ●		
Art. 170/44H114	434* (17.09)	300* (11.81)	54* (2.13)	54* (2.13)	297* (11.69)	● ● ●	●	● ● ●
Art. 170/44H148	434* (17.09)	300* (11.81)	71* (2.79)	71* (2.79)	297* (11.69)	● ●	●	● ● ●
Art. 170/51	510* (20.08)	370* (14.57)	64.5* (2.54)	64.5* (2.54)	335* (13.19)	● ● ●	●	● ● ●

*= mm. ()= inch.



170/26H44



170/26H60



170/26H76



170/33



170/37



170/44H114



170/44H148



170/51

Interni in termoformato
Customized thermoformed inlay
Kundenspezifisches thermogeformtes Inlay
Incrustation thermoformée sur mesure



Serigrafia
Screen printing
Siebdruck
Sérigraphie



Interni in spugna fustellata
Customized foam inlay
Kundenspezifische Schaumstoffeinlagen
Mousse découpée personnalisée

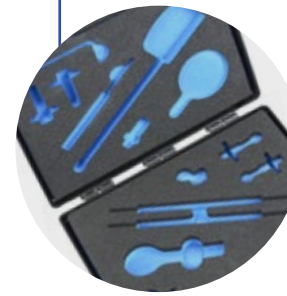

4 Colori serrature
Clip colours
Farben Verschlüsse
Couleurs de serrures

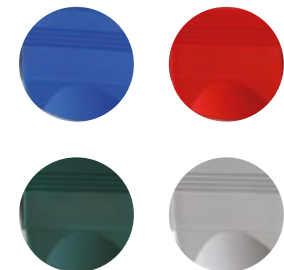

Classic Series



Interni in spugna fustellata

Customized foam inlay
Kundenspezifische Schaumstoffeinlagen
Mousse découpée personnalisée



Serigrafia

Screen printing
Siebdruck
Sérigraphie



La Linea Classic rappresenta la scelta perfetta per chi cerca una soluzione con un ottimo rapporto qualità prezzo. Valigette in polipropilene disponibili in diversi colori di serie, tra cui il trasparente, adatte ad innumerevoli applicazioni e caratterizzate da un'ampia possibilità di personalizzazione esterna (etichette e serigrafie) ed interna (spugna personalizzata).

The Classic Line is the perfect choice for those looking for a quality solution with an affordable price. Polypropylene cases available in various standard colors, including the transparent, suitable for many applications and with a wide range of external (labels and serigraphs) and internal (foams) customizations.

Die Reihe "Classic" ist die perfekte Wahl, wenn ein ausgezeichnetes Preis-/Leistungsverhältnis gewünscht ist. Diese Koffer aus Polypropylen, erhältlich in verschiedenen Standardfarben, haben diverse Möglichkeiten, um an Kundenwünsche angepasst werden zu können (Aufkleber, Siebdruck oder Schaumstoffeinlagen).

La gamme classique constitue le choix parfait pour ceux qui recherchent une solution de qualité à un prix abordable. Mallettes en polypropylène disponibles dans différents coloris standard, y compris le transparent, adaptées à de nombreuses applications, proposées avec de larges possibilités de personnalisations externes (étiquettes et sérigraphies) et internes (mousses).

DIMENSIONI INTERNE INTERNAL DIMENSIONS	LUNGHEZZA LENGTH	LARGHEZZA WIDTH	ALTEZZA FONDO BOTTOM HEIGHT	ALTEZZA COPERCHIO LID HEIGHT	LARGHEZZA MIN. INTERNA MIN. INTERNAL WIDTH	COLORI DISPONIBILI COLOURS AVAILABLE
Art. 170/16 Art. 170/16T	155* (6.10)	115* (4.53)	21* (0.83)	13* (0.51)	108* (4.25)	● ○
Art. 170/24P Art. 170/24P-T	233* (9.17)	173* (6.81)	27* (1.06)	15* (0.59)	161* (6.34)	● ● ○
Art. 170/24PH75 Art. 170/24P-TH75	233* (9.17)	173* (6.81)	43* (1.70)	29* (1.14)	161* (6.34)	● ○
Art. 170/31 Art. 170/31T	314* (12.36)	232* (9.13)	36* (1.41)	21* (0.82)	218* (8.58)	● ● ● ○
Art. 170/36 Art. 170/36T	360* (14.17)	268* (10.55)	46* (1.81)	27* (1.06)	255* (10.04)	● ● ● ○
Art. 170/40 Art. 170/40T	396* (15.59)	286* (11.26)	60* (2.36)	35* (1.37)	268* (10.55)	● ● ○

*= mm. ()= inch.



DIMENSIONI INTERNE INTERNAL DIMENSIONS	LUNGHEZZA LENGTH	LARGHEZZA WIDTH	ALTEZZA FONDO BOTTOM HEIGHT	ALTEZZA COPERCHIO LID HEIGHT	COLORI DISPONIBILI COLOURS AVAILABLE
Art. K27	244* (9.60)	174* (6.90)	20* (0.79)	21* (0.82)	●
Art. K45	320* (12.60)	216* (8.50)	36* (1.42)	38* (1.49)	●
Art. K06	392* (15.40)	266* (10.50)	55* (2.17)	38* (1.49)	●
Art. K28	436* (17.20)	338* (13.30)	61* (2.40)	42* (1.65)	●

*= mm. ()= inch.

La linea "K" presenta un design elegante mantenendo pur sempre un ottimo rapporto qualità-prezzo. L'interno squadrato permette di ottimizzare le personalizzazioni interne. Possibili anche personalizzazioni serigrafiche.

The "K" line presents itself with an elegant design, while maintaining an excellent value for money. The squared inner shape allows to easily customize the inlay. Screen printed logos can also be made for certain MOQ.

Die Reihe "K" zeichnet sich durch ihr elegantes Design und einem interessanten Preis-/Leistungsverhältnis aus. Die rechteckige Form der Koffer erlaubt es, den Innenraum für Schaumstoffeinlagen vollkommen zu nutzen. Es ist möglich, ein Logo mittels Siebdruck anzubringen (Mindestbestellmenge erforderlich)

La gamme "K" a un design contemporain et un excellent rapport qualité prix. L'intérieur lisse de la valise permet d'optimiser le volume pour un calage personnalisé. Personnalisation externe: sérigraphie possible sur les deux faces. Personnalisation interne: calage en mousse découpée.

Serigrafia
Screen printing
Siebdruck
Sérigraphie



Interni in spugna fustellata
Customized foam inlay
Kundenspezifische Schaumstoffeinlagen
Mousse découpée personnalisée



Altre valigette / Other cases / Andere Koffer / Autres valises

TC200



170/39C-105+GPB



170/39C-105



DIMENSIONI INTERNE INTERNAL DIMENSIONS	LUNGHEZZA LENGTH	LARGHEZZA WIDTH	ALTEZZA FONDO BOTTOM HEIGHT	ALTEZZA COPERCHIO LID HEIGHT	LARGHEZZA MIN. INTERNA MIN. INTERNAL WIDTH	COLORI DISPONIBILI COLOURS AVAILABLE
Art. TC200	403* (15.87)	288* (11.34)	47* (1.85)	39* (1.53)	-	●
Art. 170/39C-105	384* (15.12)	294* (11.57)	52.5* (2.07)	51.5* (2.03)	238* (9.37)	● ● ●

*= mm. ()= inch.



Primo soccorso / First Aid / Erste Hilfe / Premiers secours



7305

Due ripiani interni / Two internal shelves / Zwei interne Regale / Deux étagères internes

 386 x 243 x H 146 mm
15.20 x 9.57 x H 5.75 Inch.



Ordine minimo / Minimum order / Mindestbestellmenge / Commande minimum



7304

Separatori mobili e supporto murale / Movable dividers and wall support / Bewegliche Trennwände und Wandhalter / Étagères intérieures et support mural adapté

 430 X 280 X H 140 mm
16.92 X 11.02 X H 5.51 Inch.



Ordine minimo / Minimum order / Mindestbestellmenge / Commande minimum



170/51

 515 X 415 X H 135 mm
20.28 X 16.34 X H 5.31 Inch



170/30N

 320 X 280 X H 119 mm
12.60 X 11.02 X H 4.69 Inch.



7240

Supporto murale / Wall support / Wandhalterung / Support mural



Compatibile con tutti i seguenti modelli:

Compatible with the following items:
Kompatibel mit folgenden Artikeln:
Compatible avec les articles suivants:
170/24P, 170/24PTH75, 170/25, 170/26H44, 170/26H60, 170/26H76, 170/28, 170/31, 170/36, K27, K45



7300

Supporto murale per 170/30N
Wall support for item 170/30N
Wandhalterung für Modell 170/30N
Support mural pour article 170/30N



Bivalente valigette in PET E PP / PET and PP blister packs and cases / Klappblister und Koffer aus PET und PP / Blister et valisettes en PET et PP



A. Bivalente in PET / Thermoformed PET blister packs / Thermogeformte Klappblister aus PET / Blister thermoformes en PET

Dim. interne / Internal Dim. / Innenmaße / Dimensions internes

Art.	L mm.	W mm.	H mm.	L inch.	W inch.	H inch.
Art. 1	55	45	12	2.16	1.77	0.47
Art. 2	55	45	20	2.16	1.77	0.79
Art. 3	55	45	30	2.16	1.77	1.18
Art. 4	75	45	12	2.95	1.77	1.18
Art. 5	75	45	20	2.95	1.77	1.79
Art. 6	75	45	30	2.95	1.77	1.18
Art. 7	95	45	12	3.74	1.77	0.47
Art. 8	95	45	20	3.74	1.77	0.79
Art. 9	95	45	30	3.74	1.77	1.18
Art. 10	115	45	12	4.53	1.77	0.47
Art. 11	115	45	20	4.53	1.77	0.79
Art. 12	115	45	30	4.53	1.77	1.18
Art. 13	135	45	12	5.31	1.77	0.47
Art. 14	135	45	20	5.31	1.77	0.79
Art. 15	135	45	30	5.31	1.77	1.18
Art. 16	155	45	12	6.10	1.77	0.47
Art. 17	155	45	20	6.10	1.77	0.79
Art. 18	155	45	30	6.10	1.77	1.18
Art. 19	195	120	30	7.67	4.72	1.18
Art. 20	195	120	40	7.67	4.72	1.57
Art. 21	220	45	20	8.66	1.77	0.79
Art. 31	220	45	30	8.66	1.77	1.18
Art. 22	140	75	30	5.51	2.95	1.18
Art. 25	180	90	40	7.09	3.54	1.57
Art. 27	195	120	72	7.68	4.72	2.83
Art. 28	90	65	20	3.54	2.57	0.79
Art. 29	90	65	30	3.54	2.57	1.18
Art. 30	90	65	40	3.54	2.57	1.57
Art. 30/29	90	65	60	3.54	2.57	2.36
Art. 32	180	45	20	7.09	1.77	0.79
Art. 33	180	45	30	7.09	1.77	1.18

B. Valigette termoformate in PET / Thermoformed PET cases / Thermogeformte Koffer aus P.E.T. / Valisettes thermoformeas en P.E.T.

Dim. interne / Internal Dim. / Innenmaße / Dimensions internes

Art.	L mm.	W mm.	H mm.	L inch.	W inch.	H inch.
Art. D85	210	155	85	8.27	6.10	3.35
Art. E30	210	155	29	8.27	6.10	1.14
Art. F60	159	110	59	6.26	4.33	2.32

C. Bivalente in polipropilene / Rigid polypropylene blister pack / Hartschalenbehälter aus Polypropylen / Blisters rigides en polypropylene

Dim. interne / Internal Dim. / Innenmaße / Dimensions internes

Art.	L mm.	W mm.	H mm.	L inch.	W inch.	H inch.
Art. A1	38	48	15	1.50	1.89	0.59
Art. A2	38	48	10	1.50	1.89	0.39
Art. B1	65	47	30	2.56	1.85	1.18
Art. B2	65	47	15	2.56	1.85	0.59
Art. B3	75	60	40	2.95	2.36	1.57
Art. C1A	137	52	31	5.39	2.05	1.22
Art. C2A	137	52	17	5.39	2.05	0.67
Art. D0	125	65	18	4.92	2.56	0.71
Art. D0/4	125	65	18	4.92	2.56	0.71
Art. D1	125	65	30	4.92	2.56	1.18
Art. D2	125	65	37	4.92	2.56	1.46
Art. F1	195	70	35	7.68	2.76	1.38
Art. F2	250	70	35	9.65	2.76	1.38
Art. F3	295	70	35	11.61	2.76	1.38
Art. F4	315	55	22	12.40	2.16	0.87

Scatole / Boxes / Sortier Boxen / Boites

ART. 101/ATN/BTN/CTN/DTN/ETN/FTN/VTN

 165x112x31 mm / 6.50x4.41x1.22 Inch.

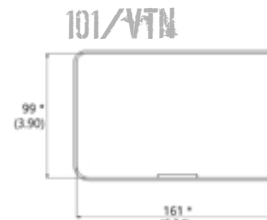
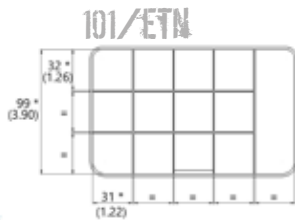
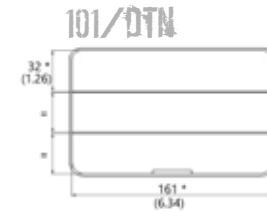
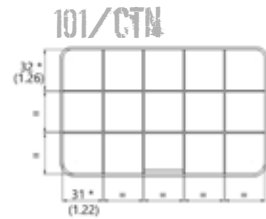
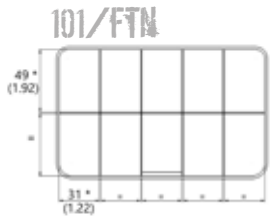
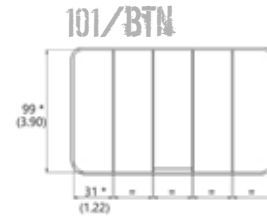
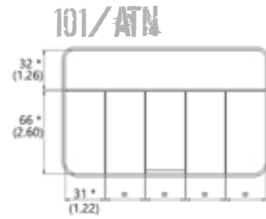

Dim. interne / Internal Dim. /
Innenmaße / Dimensions internes

* = mm.
() = inch.

ART. 191/4/6/7/12/V

 245x165x40 mm / 9.64x6.48x1.57 Inch.

 H. 33 mm / H. 1.30 Inch.

191/V



Dim. interne / Internal Dim. /
Innenmaße / Dimensions internes

* = mm.
() = inch.

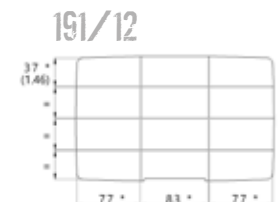
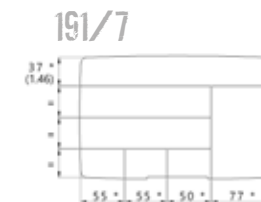
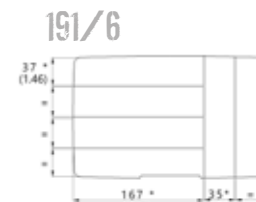
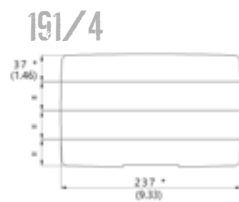

ART. 102/4-T/6-T/VT

 91x66x21 mm / 3.59x2.60x0.83 Inch.

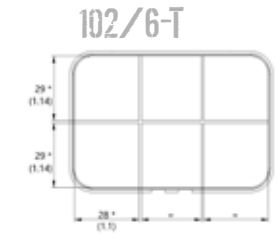
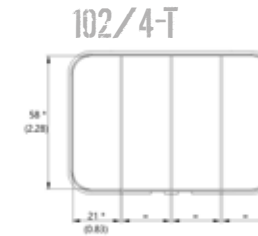
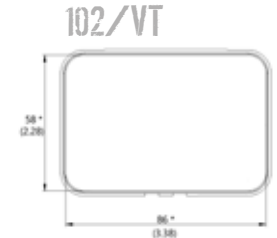

Dim. interne / Internal Dim. /
Innenmaße / Dimensions internes

* = mm.
() = inch.

Scatole / Boxes / Sortier Boxen / Boites

ART. 192/VN/14/21

 325x255xh52 mm / 12.80x10.04xh2.05 Inch.

 H. 46 mm / H. 1.81 Inch.



192/VN

192/14

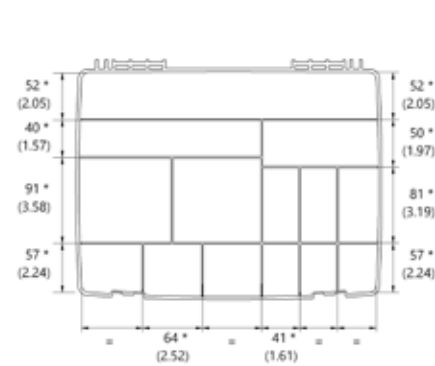

192/21

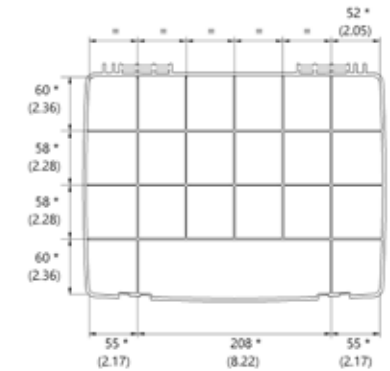

ART. 193/14/21

 325x255xh56 / 12.80x10.04xh2.20 Inch.

 H. 46 mm / H. 1.81 Inch.



ACCOPPIABILE
ATTACHABLE

193/14

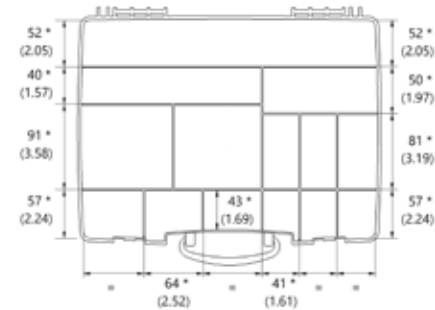

193/21

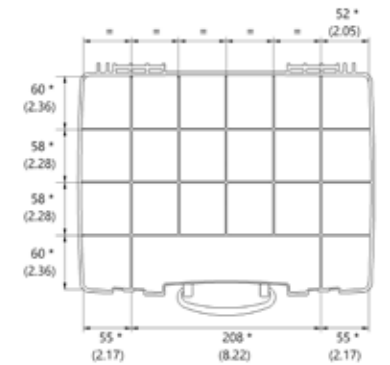

Dim. interne / Internal Dim. /
Innenmaße / Dimensions internes

* = mm.
() = inch.

ART. 194

3 - 21 scomparti mobili, serrature a clips / 3 - 21 adjustable compartments, secure clips / 3 - 21 verstellbare Unterteilungen, robuste Verschlüsse / 3 - 21 compartiments modulables, fermetures très résistantes

 364x248xh50 mm / 14.33x9.76xh1.96 Inch.

 H. 45 mm / H. 1.76 Inch.

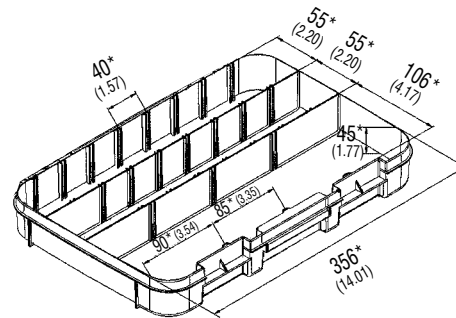

* = mm.
() = inch.

ART. 196

1 - 15 scomparti mobili / 1 - 15 adjustable compartments / 1 - 15 verstellbare Unterteilungen / 1 - 15 compartiments modulables

 276x188xh75 mm / 10.87x7.40xh2.95 Inch.

 H. 70 mm / H. 2.76 Inch.

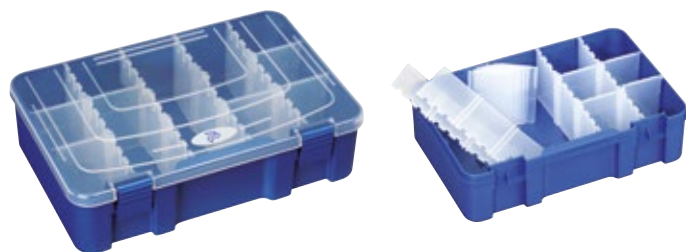

ART. 195

1 - 20 scomparti mobili / 1 - 20 adjustable compartments / 1 - 20 verstellbare Unterteilungen / 1 - 20 compartiments modulables

 276x188xh45 mm / 10.87x7.40xh1.77 Inch.

 H. 40 mm / H. 1.57 Inch.

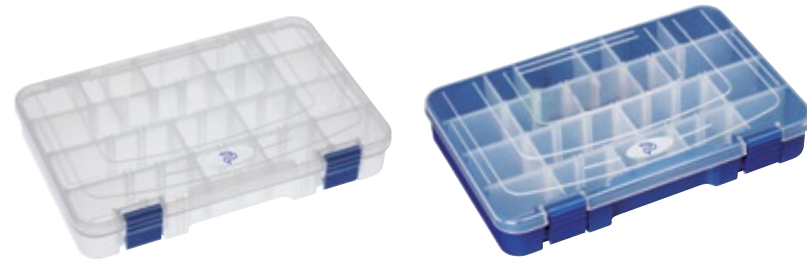

ART. 197

1 - 9 scomparti mobili / 1 - 9 adjustable compartments / 1 - 9 verstellbare Unterteilungen / 1 - 9 compartiments modulables

 276x188xh75 mm / 10.87x7.40xh2.95 Inch.

 H. 70 mm / H. 2.76 Inch.



Scatole / Boxes / Sortier Boxen / Boites

ART. SLIM198

4 - 20 scomparti mobili / 4 - 20 adjustable compartments /
4 - 20 verstellbare Unterteilungen / 4 - 20 compartiments modulables

 276x186xh27 mm / 10.87x7.32xh1.06 Inch.

 H. 24 mm / H. 0.94 Inch.



Slim lock technology

Elimina le intercapedini
garantendo una perfetta
separazione degli scomparti
Keeping things in place



ART. SLIM199

4 - 16 scomparti mobili / 4 - 16 adjustable compartments /
4 - 16 verstellbare Unterteilungen / 4 - 16 compartiments modulables

 206x147xh27 mm / 8.11x5.79xh1.06 Inch.

 H. 24 mm / H. 0.94 Inch.



ART. SLIM396

8 - 40 scomparti mobili / 8 - 40 adjustable compartments /
8 - 40 verstellbare Unterteilungen / 8 - 40 compartiments modulables

 276x186xh59 mm / 10.87x7.32xh2.32 Inch.

 H. 24 mm / H. 0.94 Inch.



ART. 150/T

Con ripiano interno / with inside shelf / mit einer Innenlade / avec plateau
et fond compartimentés

 210x107xh45 mm / 8.27x4.21xh1.77 Inch.

 H. 45 mm / H. 1.77 Inch.



180/37
 370x170xh52 mm / 14.57x6.69xh2.05 Inch.

 H. 45 mm / H. 1.77 Inch.

180/43
 432x170xh52 mm / 17.01x6.69xh2.05 Inch.

 H. 45 mm / H. 1.77 Inch.

ART. 200/C/L
 200/C: 310x105xh40 mm / 12.20x4.13x1.57 Inch.
 200/L: 387x105xh40 mm / 15.24x4.13x1.57 Inch.

200/C

200/L

 * = mm.
 () = inch.

ART. 192/V-C6

8 contenitori componibili / 8 modular containers / 8 Einsätzen / 8 éléments modulables

 325x255xh52 mm / 12.80x10.04xh2.05 Inch.

 H. 45 mm / H. 1.77 Inch.

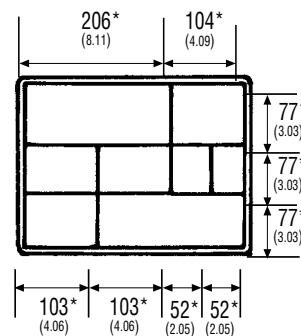
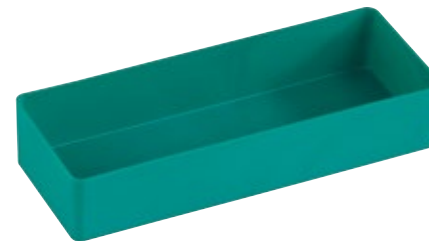
192/V-C6

 * = mm.
 () = inch.

MODULAR M/G
 203X74XH38 mm
 7.99x2.91xH1.50 inch

MODULAR

MODULAR M/M
 100x74xH38 mm
 3.94x2.91xH1.50 inch

MODULAR M/P
 74x49xH38 mm
 2.91x1.93xH1.50 inch



Plastica **Panaro**
HARDWARE



Valigie portautensili / Tool cases / Werkzeugkoffer / Valises porte-outils (TC)

MAX430 TC

 464 x 366 x H176 mm
18.27 x 14.41 x H6.93 inch.

Tasca + vano portautensili + tracolla imbottita
Pouch + tool storage system + shoulder strap
Deckeltasche + Werkzeugfach + Gepolsterter Umhängegurt
Porte-documents + Module de rangement interne amovible +
Bandoulière renforcée



MAX505 TC

 555 x 428 x H211 mm
21.85 x 16.85 x H8.31 inch.

Tasca + vano portautensili + tracolla imbottita
Pouch + tool storage system + shoulder strap
Deckeltasche + Werkzeugfach + Gepolsterter Umhängegurt
Porte-documents + Module de rangement interne amovible +
Bandoulière renforcée



MAX505 TCTR

 555 x 445 x H258 mm
21.85 x 17.52 x H10.16 inch.

Tasca + vano portautensili + trolley
Pouch + tool storage system + trolley
Deckeltasche + Werkzeugfach + Trolley
Porte-documents + Module de rangement
interne amovible + trolley



MAX520 TCTR

 585 x 361 x H238 mm
23.03 x 14.21 x H9.37 inch..

Tasca + vano portautensili + trolley
Pouch + tool storage system + trolley
Deckeltasche + Werkzeugfach + Trolley
Porte-documents + Module de rangement
interne amovible + trolley



MAX430 PU

 464 x 366 x H176 mm
18.27 x 14.41 x H6.93 inch.

Tasca + pannello portautensili + tracolla imbottita
Lid organizer + tool panel + shoulder strap
Deckeltasche + Einsatz für Werkzeuge +
Gepolsterter Umhängegurt
Porte-documents + plateau porte-outils +
bandoulière renforcée



MAX505 PU

 555 x 428 x H211 mm
21.85 x 16.85 x H8.31 inch.

Tasca + doppio pannello portautensili + tracolla imbottita
Lid organizer + double tool panel + shoulder strap
Deckeltasche + doppelter Einsatz für Werkzeuge +
Gepolsterter Umhängegurt
Porte-documents + double plateau porte-outils +
bandoulière renforcée



MAX505 PU TR

PROCASE 170/48H184PU

 460 x 325 x H170 mm
18.11 x 12.79 x H6.70 inch.

Tasca + doppio pannello portautensili +
divisori interni porta minuteria
*Lid organizer + double tool panel +
internal dividers*
Deckeltasche + doppelter Einsatz für Werkzeuge +
interne Trennwände
Porte-documents + double plateau porte-outils +
diviseurs internes



Valigie portautensili / Tool cases / Werkzeugkoffer / Valises porte-outils

ART. 120/V

 400x180xh132 mm / 15.75x7.09xh5.20 Inch.



ART. 141F

 320x120xh160 mm / 12.60x4.72xh6.30 Inch.



ART. 158/V

 530x290xh270 mm / 20.87x11.42xh10.63 Inch.

 445 x 220 x 230 mm / 17.52x8.66x9.05 Inch.



ART. 161/V

 406x255xh244 mm / 15.98x10.03xh9.61 Inch.

 H 215 mm / H 8.46 Inch.



Valigie portautensili / Tool cases / Werkzeugkoffer / Valises porte-outils

ART. 163

 394x215x195 mm / 15.51x8.46x7.68 Inch.



ART. 164

 394x215x195 mm / 15.51x8.46x7.68 Inch.



ART. 165

 514x280x260 mm / 20.24x11.02x10.24 Inch.



Valigie portautensili / Tool cases / Werkzeugkoffer / Valises porte-outils

ART. 501 - SUPERBOX

 420x303xh400 mm / 16.53x11.92xh15.75 Inch.



ART. 502 - SUPERBOX

 420x303xh400 mm / 16.53x11.92xh15.75 Inch.



4 boxes with mobile dividers (art.194)



ART. 503 - SUPERBOX

 420x303xh400 mm / 16.53x11.92xh15.75 Inch.



4 boxes with mobile dividers (art.194)



New Panaro Easy Latching System



4 drawers with internal partitions



BOX 105/148/209/310



 * = mm.
() = inch.

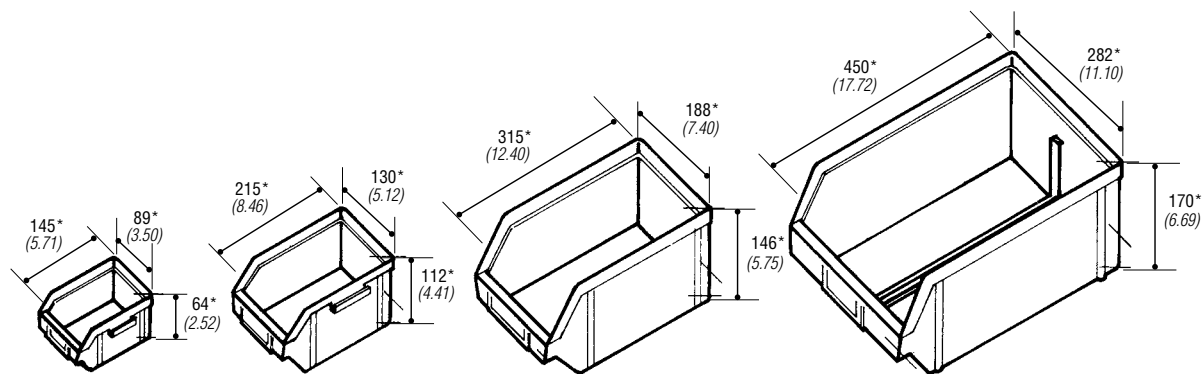

BOX 105

BOX 148

BOX 209

BOX 310

ESPOSITORI/DISPLAY PLATES/AUSSTELLUNGSDISPLAYS/PLAQUETTES POUR LINÉAIRE

110x35x1.5 mm - 4.33x1.38x0.06 inch
 145x55x1.5 mm - 5.71x2.16x0.06 inch
 170x70x1.5 mm - 6.69x2.75x0.06 inch





TECHNICAL FEATURES

ARTICOLO ITEM	DIMENSIONI ESTERNE EXTERNAL DIMENSIONS	DIMENSIONI INTERNE DIMENSIONS
MAX001	175 x 115 x H47 mm / 6.88 x 4.52 x H 1.85 inch	157 x 82 x H41 mm / 6.18 x 3.22 x H1.61 inch
MAX002	230 x 175 x H53 mm / 9.05 x 6.88 x H2.08 inch	212 x 140 x H47 mm / 8.34 x 5.51 x H1.85 inch
MAX003	350 x 230 x H59 mm / 13.77 x 9.05 x H2.32 inch	316 x 195 x H53 mm / 12.44 x 7.67 x H2.08 inch
MAX004	350 x 230 x H86 mm / 13.77 x 9.05 x H3.38 inch	316 x 195 x H81 mm / 12.44 x 7.67 x H3.18 inch
MAX235H105	258 x 243 x H117,5 mm / 10.16 x 9.56 xH 4.62 inch	235 x 180 x H106 mm / 9.25 x 7.08 x H4.17 inch
MAX235H155	258 x 243 x H167.5 mm / 10.16 x 9.56 x H6.59 inch	235 x 180 x H156 mm / 9.25 x 7.08 x H6.14 inch
MAX300	336 x 300 x H148 mm / 13.23 x 11.81 x H5.83 inch	300 x 225 x H132 mm / 11.81 x 8.86 x H5.20 inch
MAX380H115	414 x 345 x H129 mm / 16.30 x 13.58 x H5.08 inch	380 x 270 x H115 mm / 14.96 x 10.62 x H4.52 inch
MAX380H160	414 x 345 x H174 mm / 16.29 x 13.58 x H6.85 inch	380 x 270 x H160 mm / 14.96 x 10.62 x H6.29 inch
MAX430	464 x 366 x H176 mm / 18.27 x 14.41 x H6.93 inch	426 x 290 x H159 mm / 16.77 x 11.42 x H6.26 inch
MAX465H125	502 x 415 x H141 mm / 19.76 x 16.34 x H5.55 inch	465 x 335 x H125 mm / 18.31 x 13.19 x H4.92 inch
MAX465H220	502 x 415 x H246 mm / 19.76 x 16.34 x H9.69 inch	465 x 335 x H220mm / 18.31 x 13.19 x H8.66 inch
MAX465H220TR	502 x 422 x H 267 mm / 19.76 x 16.61 x H 10.51 inch	465 x 335 x H 220 mm / 18.31 x 13.19 x 8.66 inch
MAX505	555 x 428 x H211 mm / 21.85 x 16.85 x H8.31 inch	500 x 350 x H194 mm / 19.69 x 13.78 x H7.64 inch
MAX505TR	555 x 445 x H258 mm / 21.85 x 17.52 x H10.16 inch	500 x 350 x H194 mm / 19.69 x 13.78 x H7.64 inch
MAX505H280	555 x 428 x H306 mm / 21.85 x 16.85 x H12.04 inch	500 x 350 x H280 mm / 19.69 x 13.78 x H11 inch
MAX505H280TR	555 x 437 x H326 mm / 21.85 x 17.20 x H12.84 inch	500 x 350 x H280 mm / 19.69 x 13.78 x H11 inch
MAX520	574 x 361 x H225 mm / 22.60 x 14.21 x H8.86 inch	520 x 290 x H200 mm / 20.47 x 11.42 x H7.87 inch
MAX520TR	585 x 361 x H238 mm / 23.03 x 14.21 x H9.37 inch	520 x 290 x H200 mm / 20.47 x 11.42 x H7.87 inch
MAX540H190	594 x 473 x H215 mm / 23.39 x 18.62 x H8.46 inch	538 x 405 x H190 mm / 21.18 x 15.94 x H7.48 inch
MAX540H190TR	604 x 473 x H225 mm / 23.78 x 18.62 x H8.86 inch	538 x 405 x H190 mm / 21.18 x 15.94 x H7.48 inch
MAX540H245	594 x 473 x H270 mm / 23.39 x 18.62 x H10.63 inch	538 x 405 x H245 mm / 21.18 x 15.94 x H9.64 inch
MAX540H245TR	604 x 473 x H283 mm / 23.78 x 18.62 x H11.14 inch	538 x 405 x H245 mm / 21.18 x 15.94 x H9.64 inch
MAX620H250	687 x 528 x H276 mm / 27.05 x 20.79 x H10.86 inch	620 x 460 x H250 mm / 24.40 x 18.11 x H9.84 inch
MAX620H250TR	687 x 528 x H286 mm / 27.05 x 20.79 x H11.26 inch	620 x 460 x H250 mm / 24.40 x 18.11 x H9.84 inch
MAX620H340	687 x 528 x H366 mm / 27.05 x 20.79 x H14.41 inch	620 x 460 x H340 mm / 24.41 x 18.11 x H13.38 inch
MAX620H340TR	687 x 528 x H376 mm / 27.05 x 20.79 x H14.80 inch	620 x 460 x H340 mm / 24.41 x 18.11 x H13.38 inch
MAX750H280	816 x 540 x H306 mm / 32.12 x 21.26 x H12.04 inch	750 x 480 x H280 mm / 29.52 x 18.90 x H11 inch
MAX750H400	816 x 540 x H426mm / 32.12 x 21.26 x H16.77 inch	750 x 480 x H400 mm / 29.52 x 18.90 x H15.75 inch
MAX820	880 x 660 x H483mm / 34.64 x 25.98 x H19.01 inch	820 x 600 x H450 mm / 32.28 x 23.62 x H17.71 inch
MAX800	850 x 440 x H158 mm / 33.46 x 17.32 x H6.22 inch	800 x 370 x H140 mm / 31.49 x 14.57 x H5.51 inch
MAX1100	1177 x 450 x H158 mm / 46.34 x 17.72 x H6.22 inch	1100 x 370 x H140 mm / 43.30 x 14.57 x H5.51 inch

TECHNICAL FEATURES

COPERCHIO <i>LID</i>	FONDO <i>BOTTOM</i>	PESO SENZA SPUGNE (KG/LB) <i>WEIGHT W/O FOAM (KG/LB)</i>	PESO CON SPUGNE (KG/LB) <i>WEIGHT W.FOAM (KG/LB)</i>	COLORI <i>COLOURS</i>	CERTIFICAZIONI <i>CERTIFICATES</i>
12 mm / 0.47 inch	29 mm / 1.14 inch	0,14 kg / 0.30 lb	0,15 kg / 0.33 lb	○ ●	IP67
14 mm / 0.55 inch	33 mm / 1.33 inch	0,26 kg / 0.57 lb	0,28 kg / 0.61 lb	○ ●	IP67
16 mm / 0.63 inch	37 mm / 1.46 inch	0,48 kg / 1.05 lb	0,52 kg / 1.14 lb	○ ●	IP67
16 mm / 0.63 inch	65 mm / 2.55 inch	0,54 kg / 1.19 lb	0,62 kg / 1.36 lb	○ ●	IP67
25 mm / 0.98 inch	81 mm / 3.19 inch	0,82 kg / 1.80 lb	0,88 kg / 1.94 lb	● ●	IP67, STANAG 4280, DEF STAN 81-41
25 mm / 0.98 inch	131 mm / 5.16 inch	0,96 kg / 2.11 lb	1,06 kg / 2.33 lb	● ●	IP67, STANAG 4280, DEF STAN 81-41
33 mm / 1.30 inch	99 mm / 3.90 inch	1,62 kg / 3.57 lb	1,76 kg / 3.88 lb	● ● ●	IP67, STANAG 4280, DEF STAN 81-41
36 mm / 1.42 inch	79 mm / 3.11 inch	2,10 kg / 4.63 lb	2,35 kg / 5.18 lb	●	IP67, STANAG 4280, DEF STAN 81-41
36 mm / 1.42 inch	124 mm / 4.90 inch	2,455 kg / 5.41 lb	2,755 kg / 6.07 lb	●	IP67, STANAG 4280, DEF STAN 81-41
45 mm / 1.77 inch	114 mm / 4.49 inch	2,76 kg / 6.08 lb	3,04 kg / 6.70 lb	● ● ●	IP67, STANAG 4280, DEF STAN 81-41, ATA 300
40 mm / 1.57 inch	85 mm / 3.35 inch	2,62 kg / 5.77 lb	2,92 kg / 6.43 lb	●	IP67, STANAG 4280, DEF STAN 81-41
40 mm / 1.57 inch	180 mm / 7.09 inch	3,44 kg / 7.58 lb	3,98 kg / 8.77 lb	●	IP67, STANAG 4280, DEF STAN 81-41
40 mm / 1.57 inch	180 mm / 7.09 inch	4,46 kg / 9.83 lb	5 kg / 11.02 lb	●	IP67, STANAG 4280, DEF STAN 81-41
58 mm / 2.28 inch	136 mm / 5.36 inch	3,9 kg / 8.59 lb	4,38 kg / 9.65 lb	● ● ●	IP67, STANAG 4280, DEF STAN 81-41
58 mm / 2.28 inch	136 mm / 5.36 inch	5,04 kg / 11.11 lb	5,54 kg / 12.21 lb	● ● ●	.
58 mm / 2.28 inch	222 mm / 8.74 inch	5,1 kg / 11.24 lb	6,03 kg / 13.29 lb	●	IP67, STANAG 4280, DEF STAN 81-41
58 mm / 2.28 inch	222 mm / 8.74 inch	6,1 kg / 13.44 lb	7,03 kg / 15.49 lb	●	IP67, STANAG 4280, DEF STAN 81-41
45 mm / 1.77 inch	155 mm / 6.10 inch	3,58 kg / 7.89 lb	4,02 kg / 8.86 lb	●	IP67, STANAG 4280, DEF STAN 81-41
45 mm / 1.77 inch	155 mm / 6.10 inch	5,06 kg / 11.15 lb	5,50 kg / 12.12 lb	●	IP67, STANAG 4280, DEF STAN 81-41
50 mm / 1.97 inch	140 mm / 5.51 inch	4,76 kg / 10.49 lb	5,4 kg / 11.9 lb	●	IP67, STANAG 4280, DEF STAN 81-41
50 mm / 1.97 inch	140 mm / 5.51 inch	6,28 kg / 13.84 lb	6,94 kg / 15.3 lb	●	IP67, STANAG 4280, DEF STAN 81-41
50 mm / 1.97 inch	195 mm / 7.68 inch	5,3 kg / 11.68 lb	6,16 kg / 13.58 lb	●	IP67, STANAG 4280, DEF STAN 81-41
50 mm / 1.97 inch	195 mm / 7.68 inch	6,84 kg / 15.07 lb	7,7 kg / 16.97 lb	●	IP67, STANAG 4280, DEF STAN 81-41
60 mm / 2.36 inch	190 mm / 7.48 inch	6,98 kg / 15.38 lb	8,14 kg / 17.94 lb	●	IP67, STANAG 4280, DEF STAN 81-41
60 mm / 2.36 inch	190 mm / 7.48 inch	8,5 kg / 18.73 lb	9,7 kg / 21.38 lb	●	IP67, STANAG 4280, DEF STAN 81-41
60 mm / 2.36 inch	280 mm / 11.02 inch	8,08 kg / 17.81 lb	9,6 kg / 21.16 lb	●	IP67, STANAG 4280, DEF STAN 81-41
60 mm / 2.36 inch	280 mm / 11.02 inch	9,6 kg / 21.16 lb	11,12 kg / 24.51 lb	●	IP67, STANAG 4280, DEF STAN 81-41
60 mm / 2.36 inch	220 mm / 8.66 inch	10,2 kg / 22.09 lb	11,8 kg / 26.01 lb	●	IP67, STANAG 4280, DEF STAN 81-41
60 mm / 2.36 inch	340 mm / 13.38 inch	12,1 kg / 26.67 lb	13,7 kg / 30.2 lb	●	IP67, STANAG 4280, DEF STAN 81-41
70 mm / 2.75 inch	380 mm / 14.96 inch	16 kg / 35.27 lb	21 kg / 46.29 lb	●	IP67, STANAG 4280, DEF STAN 81-41
45 mm / 1.77 inch	95 mm / 3.74 inch	6,2 kg / 13.66 lb	7,06 kg / 15.56 lb	●	IP67, STANAG 4280, DEF STAN 81-41
45 mm / 1.77 inch	95 mm / 3.74 inch	7,86 kg / 17.32 lb	8,72 kg / 19.22 lb	●	IP67, STANAG 4280, DEF STAN 81-41

FOAM SET CONFIGURATION

ARTICOLO ARTICLE	SPUGNA LISCIA BASE FOAM	SPUGNA CUBETTATA (S) CUBED FOAM (S)	SPUGNA BUGNATA COPERCHIO (GPB) LID CONVOLUTED FOAM (GPB)	SPUGNA BUGNATA FONDO (GPB) BASE CONVOLUTED FOAM (GPB)
MAX235H105S	1 x 20 mm / 1 x 0.79 inch	2 x 30 mm / 2 x 1.18 inch	1 x 22 mm / 1 x 0.87 inch	–
MAX235H155S	1 x 30 mm / 1 x 1.18 inch	2 x 50 mm / 2 x 1.97 inch	1 x 22 mm / 1 x 0.87 inch	–
MAX300S	1 x 20 mm / 1 x 0.79 inch	2 x 35 mm / 2 x 1.38 inch	1 x 35 mm / 1 x 1.38 inch	–
MAX380H115S	1 x 10 mm / 1 x 0.39 inch	2 x 33 mm / 2 x 1.30 inch	1 x 35 mm / 1 x 1.38 inch	–
MAX380H160S	1 x 10 mm / 1 x 0.39 inch	2 x 55 mm / 2 x 2.16 inch	1 x 35 mm / 1 x 1.38 inch	–
MAX430S	1 x 20 mm / 1 x 0.79 inch	2 x 40 mm / 2 x 1.57 inch	1 x 45 mm / 1 x 1.77 inch	–
MAX465H125S	1 x 10 mm / 1 x 0.39 inch	2 x 35 mm / 2 x 1.38 inch	1 x 35 mm / 1 x 1.38 inch	–
MAX465H220S	1 x 20 mm / 1 x 0.79 inch	3 x 50 mm / 3 x 1.97 inch	1 x 35 mm / 1 x 1.38 inch	–
MAX505S	1 x 20 mm / 1 x 0.79 inch	2 x 55 mm / 2 x 2.16 inch	1 x 50 mm / 1 x 1.97 inch	–
MAX505H280S	1 x 50 mm / 1 x 1.97 inch	3 x 55 mm / 3 x 2.16 inch	1 x 50 mm / 1 x 1.97 inch	–
MAX520S	1 x 30 mm / 1 x 1.18 inch	2 x 60 mm / 2 x 2.36 inch	1 x 45 mm / 1 x 1.77 inch	–
MAX540H190S	1 x 15 mm / 1 x 0.59 inch	2 x 60 mm / 2 x 2.36 inch	1 x 50 mm / 1 x 1.97 inch	–
MAX540H245S	1 x 15 mm / 1 x 0.59 inch	3 x 60 mm / 3 x 2.36 inch	1 x 50 mm / 1 x 1.97 inch	–
MAX620H250S	1 x 40 mm / 1 x 1.57 inch	3 x 50 mm / 3 x 1.97 inch	1 x 50 mm / 1 x 1.97 inch	–
MAX620H340S	1 x 40 mm / 1 x 1.57 inch	2 x 55 mm + 2 x 65 mm / 2 x 2.16 inch + 2 x 2.56 inch	1 x 50 mm / 1 x 1.97 inch	–
MAX750H280S	1 x 40 mm / 1 x 1.57 inch	3 x 60 mm / 3 x 2.36 inch	1 x 55 mm / 1 x 2.16 inch	–
MAX750H400S	1 x 40 mm / 1 x 1.57 inch	5 x 60 mm / 5 x 2.36 inch	1 x 55 mm / 1 x 2.16 inch	–
MAX820S	1 x 50 mm / 1 x 1.97 inch	5 x 65 mm / 5 x 2.56 inch	1 x 65 mm / 1 x 2.56 inch	–
MAX800S	1 x 15 mm / 1 x 0.59 inch	2 x 40 mm / 2 x 1.57 inch	1 x 45 mm / 1 x 1.77 inch	–
MAX800GPB	–	–	1 x 45 mm / 1 x 1.77 inch	1 x 90 mm / 1 x 3.54 inch
MAX1100S	1 x 15 mm / 1 x 0.59 inch	2 x 40 mm / 2 x 1.57 inch	1 x 45 mm / 1 x 1.77 inch	–
MAX1100GPB	–	–	1 x 45 mm / 1 x 1.77 inch	1 x 90 mm / 1 x 3.54 inch
MAX001S	1 x 5 mm / 1 x 0.2 inch	1 x 25 mm / 1 x 0.98 inch	1 x 12 mm / 1 x 0.47 inch	–
MAX001GPB	–	–	1 x 12 mm / 1 x 0.47 inch	1 x 25 mm / 1 x 0.98 inch
MAX002S	1 x 5 mm / 1 x 0.2 inch	1 x 25 mm / 1 x 0.98 inch	1 x 12 mm / 1 x 0.47 inch	–
MAX002GPB	–	–	1 x 12 mm / 1 x 0.47 inch	1 x 30 mm / 1 x 1.18 inch
MAX003S	1 x 10 mm / 1 x 0.39 inch	1 x 25 mm / 1 x 0.98 inch	1 x 15 mm / 1 x 0.59 inch	–
MAX003GPB	–	–	1 x 15 mm / 1 x 0.59 inch	1 x 35mm / 1 x 1.38 inch
MAX004S	1 x 5 mm / 1 x 0.2 inch	2 x 30 mm / 2 x 1.18 inch	1 x 15 mm / 1 x 0.59 inch	–

PACKING AND WEIGHT LIST

CODICE ARTICOLO ARTICLE NUMBER	N. PEZZI CONFEZIONE N PIECES PER CARTON	N. PEZZI M3 PIECES PER M3	CUB. IMB. PACKAGING CUBIC VOLUME	PESO CARTONE KG WEIGHT OF THE CARTON IN KG	N. PEZZI X CONTAINER 20' PCS X 20' CNT FLOOR LOADED	N. PEZZI X CONTAINER 40' PCS X 40' CNT FLOOR LOADED	N. CARTONI X PALETTA CARTONS X PALLETS	DIMENSIONI PALETTE PALLET DIMENSIONS
170/16/T	45	1097	0,041	3,53	29.619	61.432	48	82 x 120 x 228 cm
170/24P	26	406	0,064	5,90	10.962	22.736	32	80 x 125 x 217 cm
170/24P H75	16	250	0,064	4,19	6.750	14.000	32	80 x 125 x 217 cm
170/25 IMP	100	813	0,123	19,02	21.951	45.528	18	80 x 132 x 244 cm
170/26H44	42	358	0,117	11,42	9.666	20.048	21	80 x 128 x 246 cm
170/26H60	30	256	0,117	9,05	6.912	14.336	21	80 x 128 x 246 cm
170/26H76	24	205	0,117	7,94	5.535	11.480	21	80 x 128 x 246 cm
170/28	46	317	0,145	14,96	8.559	17.752	14	80 x 120 x 226 cm
170/30N	8	81	0,098	5,04	2.187	4.536	20	95 x 120 x 210 cm
170/31	20	162	0,123	7,67	4.374	9.072	12	80 x 120 x 204 cm
170/33	12	99	0,120	7,54	2.673	5.544	16	80 x 122 x 230 cm
170/34H96	10	85	0,117	9,37	2.295	4.760	16	80 x 125 x 218 cm
170/34H128	8	68	0,116	6,72	1.836	3.808	16	80 x 125 x 226 cm
170/34H160	6	51	0,117	6,30	1.377	2.856	16	80 x 125 x 218 cm
170/36	10	105	0,095	5,68	2.835	5.880	20	80 x 127 x 215 cm
170/37	8	62	0,127	6,10	1.674	3.472	16	80 x 127 x 216 cm
170/38N	10	76	0,131	6,77	2.052	4.256	16	82 x 122 x 226 cm
170/39C - 105	8	65	0,123	8,14	1.755	3.640	16	82 x 130 x 203 cm
170/40	8	67	0,119	6,86	1.809	3.752	15	80 x 127 x 227 cm
159	3	19	0,157	8,09	513	1.064	12	82 x 120 x 228 cm
170/43H122	6	49	0,121	7,80	1.323	2.744	18	80 x 125 x 240 cm
170/43H156	4	38	0,103	5,92	1.026	2.128	18	80 x 125 x 209 cm
170/43H190	3	31	0,096	4,97	837	1.736	18	80 x 124 x 200 cm
170/44H114	6	46	0,128	7,00	1.242	2.576	15	85 x 123 x 225 cm
170/44H148	5	36	0,137	6,60	972	2.016	15	85 x 123 x 240 cm
K27	26	406	0,064	4,81	10.962	22.736	32	80 x 125 x 217 cm
K45	16	133	0,120	6,56	3.591	7.448	12	80 x 120 x 205 cm
K28	5	47	0,105	5,63	1.269	2.632	16	83 x 120 x 232 cm
K06	10	71	0,140	7,81	1.917	3.976	12	80 x 125 x 210 cm

PACKING AND WEIGHT LIST

CODICE ARTICOLO ARTICLE NUMBER	N. PEZZI CONFEZIONE N PIECES PER CARTON	N. PEZZI M3 PIECES PER M3	CUB. IMB. PACKAGING CUBIC VOLUME	PESO CARTONE KG WEIGHT OF THE CARTON IN KG	N. PEZZI X CONTAINER 20' PCS X 20' CNT FLOOR LOADED	N. PEZZI X CONTAINER 40' PCS X 40' CNT FLOOR LOADED	N. CARTONI X PALETTA CARTONS X PALLETS	DIMENSIONI PALETTE PALLET DIMENSIONS
170/48 H132	4	36	0,110	7,47	972	2.016	20	90 x 120 x 230 cm
170/48 H160	4	31	0,128	8,04	837	1.736	15	90 x 120 x 210 cm
170/48 H184	4	26	0,150	8,56	702	1.456	15	90 x 120 x 235 cm
170/48 H184 PU	4	26	0,150	16,24	702	1.456	15	90 x 120 x 235 cm
170/51N	5	32	0,158	7,50	864	1.792	12	85 x 120 x 218 cm
170/60 H144	5	26	0,191	11,93	702	1.456	12	86 x 122 x 234 cm
170/60 H184	4	20	0,199	10,25	540	1.120	12	86 x 122 x 242 cm
170/60 H224	3	16	0,181	8,41	432	896	12	86 x 123 x 222 cm
ESP. 110	2.500 (250)	49.019	0,051	15,76	1.323.513	2.745.064	36	80 x 120 x 237 cm
ESP. 145	1.500 (250)	29.411	0,051	15,76	794.097	1.647.016	36	80 x 120 x 237 cm
ESP. 170	1.000 (250)	19.607	0,051	15,76	529.389	1.097.992	36	80 x 120 x 237 cm
101/ATN/BTN/CTN/DTN/ETN/FTN/VTN	120 (20)	1.224	0,098	14,16	33.048	68.544	24	80 x 133 x 237 cm
102/VT/4T/6T	252 (18)	4.941	0,051	7,20	133.407	276.696	36	80 x 120 x 237 cm
191/4N/6N/7N/12N/VN	30	566	0,053	6,45	15.282	31.696	30	80 x 120 x 225 cm
192/14N/21N/VN	21	223	0,094	9,89	6.021	12.488	24	80 x 135 x 243 cm
193/14N/21N	18	206	0,087	9,02	5.562	11.536	24	80 x 135 x 216 cm
194	18	197	0,091	8,20	5.319	11.032	21	80 x 120 x 238 cm
195 / 195T	20	377	0,053	7,46	10.179	21.112	36	80 x 120 x 236 cm
196 - 197	12	226	0,053	5,57	6.102	12.656	36	80 x 120 x 236 cm
198	20	606	0,033	6,36	16.362	33.936	56	80 x 120 x 224 cm
199	72 (12)	734	0,098	14,76	19.818	41.104	24	80 x 133 x 237 cm
396	10	294	0,034	6,36	7.938	16.464	56	80 x 120 x 224 cm
200/C	50	510	0,098	9,87	13.770	28.560	24	80 x 120 x 237 cm
200/L	42	428	0,098	10,53	11.556	23.968	24	80 x 120 x 237 cm
M / P	500	3846	0,130	11,23	103.842	215.376	16	82 x 120 x 224 cm
M / M	250	1.923	0,130	8,73	51.921	107.688	16	82 x 120 x 224 cm
M / G	100	769	0,130	6,23	20.763	43.064	16	82 x 120 x 224 cm
180/37	26	232	0,112	10,86	6.264	12.992	20	88 x 123 x 227 cm
180/43	21	213	0,098	8,96	5.751	11.928	16	80 x 120 x 210 cm

PACKING AND WEIGHT LIST

CODICE ARTICOLO ARTICLE NUMBER	N. PEZZI CONFEZIONE N PIECES PER CARTON	N. PEZZI M3 PIECES PER M3	CUB. IMB. PACKAGING CUBIC VOLUME	PESO CARTONE KG WEIGHT OF THE CARTON IN KG	N. PEZZI X CONTAINER 20' PCS X 20' CNT FLOOR LOADED	N. PEZZI X CONTAINER 40' PCS X 40' CNT FLOOR LOADED	N. CARTONI X PALETTA CARTONS X PALLETS	DIMENSIONI PALETTE PALLET DIMENSIONS
150	44	862	0,051	8,46	23.274	48.272	36	80 x 120 x 237 cm
BOX 105	80	824	0,097	7,13	22.248	46.144	20	85 x 120 x 240 cm
BOX 148	27	278	0,097	7,75	7.506	15.568	20	85 x 120 x 240 cm
BOX 209	16	108	0,148	10,75	2.916	6.048	12	80 x 120 x 220 cm
BOX 310	4	33	0,120	5,34	891	1.848	15	84 x 120 x 235 cm
501 - 502 - 503	2	16	0,118	8,44	432	896	20	88 x 123 x 227 cm
165	6	25	0,233	13,25	675	1.400	8	82 x 120 x 227 cm
164	8	61	0,130	7,72	1.647	3.416	15	80 x 122 x 215 cm
163	8	61	0,130	8,70	1.647	3.416	15	80 x 123 x 215 cm
161/V	6	35	0,169	7,12	945	1.960	12	80 x 125 x 220 cm
158	4	22	0,181	9,52	594	1.232	16	110 x 130 x 235 cm
120/V	9	96	0,093	8,54	2.592	5.376	20	81 x 113 x 218 cm
141 F	20	156	0,128	12,72	4.212	8.736	16	80 x 134 x 215 cm
TC 200	12	71	0,169	8,74	1.917	3.976	12	80 x 127 x 237 cm
7305	6	62	0,095	5,10	1.674	3.472	21	80 x 120 x 240 cm
7240	200	3921	0,051	7,70	105.867	219.576	36	80 x 120 x 230 cm
7300	90	1764	0,051	5,45	47.628	98.784	36	86 x 120 x 237 cm
7304	10	54	0,187	11,02	1.458	3.024	10	80 x 120 x 243 cm

PACKING LIST WATERPROOF CASES MAX RANGE

<i>CODICE ARTICOLO ARTICLE NUMBER</i>	<i>N. PEZZI CONFEZIONE N PIECES PER CARTON</i>	<i>N. PEZZI M3 PIECES PER M3</i>	<i>CUB. IMB. PACKAGING CUBIC VOLUME</i>	<i>PESO CARTONE KG WEIGHT OF THE CARTON IN KG</i>	<i>N. PEZZI X CONTAINER 20' PCS X 20' CNT FLOOR LOADED</i>	<i>N. PEZZI X CONTAINER 40' PCS X 40' CNT FLOOR LOADED</i>	<i>N. CARTONI X PALETTA CARTONS X PALLETS</i>	<i>DIMENSIONI PALETTE PALLET DIMENSIONS</i>
MAX001VT/T	12	809	0,015	1,95	21.843	45.304	133	80 x 120 x 228 cm
MAX001S/MAX001VGPB	12	809	0,015	2,08	21.843	45.304	133	80 x 120 x 228 cm
MAX002V/T	12	353	0,034	3,59	9.531	19.768	60	80 x 123 x 239 cm
MAX002S/MAX002VGPB	12	353	0,034	3,89	9.531	19.768	60	80 x 123 x 239 cm
MAX003V/T	6	176	0,034	3,35	4.752	9.856	60	80 x 123 x 239 cm
MAX003S/MAX003VGPB	6	176	0,034	3,71	4.752	9.856	60	80 x 123 x 239 cm
MAX004V/T	4	117	0,034	2,62	3.159	6.552	60	80 x 123 x 239 cm
MAX004S	4	117	0,034	2,87	3.159	6.552	60	80 x 123 x 239 cm
MAX235H105	4	112	0,035	3,85	3.024	6.272	48	80 x 120 x 234 cm
MAX235H105S	4	112	0,035	4,09	3.024	6.272	48	80 x 120 x 234 cm
MAX235H155	4	78	0,051	4,52	2.106	4.368	36	80 x 120 x 230 cm
MAX235H155S	4	78	0,051	4,92	2.106	4.368	36	80 x 120 x 230 cm
MAX300	4	59	0,067	7,48	1.593	3.304	28	80 x 121 x 239 cm
MAX300S	4	59	0,067	8,04	1.593	3.304	28	80 x 121 x 239 cm
MAX380H115	2	42	0,047	4,32	1.134	2.352	42	80 x 122 x 225 cm
MAX380H115S	2	42	0,047	4,68	1.134	2.352	42	80 x 122 x 225 cm
MAX380H160	2	32	0,0612	5,00	864	1.792	36	80 x 122 x 243 cm
MAX380H160S	2	32	0,0612	5,52	864	1.792	36	80 x 122 x 243 cm
MAX430	2	28	0,070	6,39	756	1.568	30	86 x 120 x 239 cm
MAX430S	2	28	0,070	6,95	756	1.568	30	86 x 120 x 239 cm
MAX430PU/MAX430TC	2	28	0,070	8,71	756	1.568	30	86 x 120 x 239 cm
MAX465H125	1	26	0,038	3,24	702	1.456	56	83 x 120 x 241 cm
MAX465H125S	1	26	0,038	3,54	702	1.456	56	83 x 120 x 241 cm
MAX465H220	1	16	0,061	4,22	432	896	28	83 x 120 x 216 cm
MAX465H220S	1	16	0,061	4,76	432	896	28	83 x 120 x 216 cm
MAX465H220TR	1	15	0,066	5,24	405	840	28	83 x 120 x 230 cm
MAX465H220STR	1	15	0,066	5,76	405	840	28	83 x 120 x 230 cm
MAX505	1	16	0,060	4,74	432	896	36	86 x 120 x 226 cm
MAX505S	1	16	0,060	5,22	432	896	36	86 x 120 x 226 cm

PACKING LIST WATERPROOF CASES MAX RANGE

<i>CODICE ARTICOLO ARTICLE NUMBER</i>	<i>N. PEZZI CONFEZIONE N PIECES PER CARTON</i>	<i>N. PEZZI M3 PIECES PER M3</i>	<i>CUB. IMB. PACKAGING CUBIC VOLUME</i>	<i>PESO CARTONE KG WEIGHT OF THE CARTON IN KG</i>	<i>N. PEZZI X CONTAINER 20' PCS X 20' CNT FLOOR LOADED</i>	<i>N. PEZZI X CONTAINER 40' PCS X 40' CNT FLOOR LOADED</i>	<i>N. CARTONI X PALETTA CARTONS X PALLETS</i>	<i>DIMENSIONI PALETTE PALLET DIMENSIONS</i>
MAX505PU/MAX505TC	1	16	0,060	6,86	432	896	36	86 x 120 x 226 cm
MAX505TR	1	13	0,074	6,14	351	728	24	80 x 120 x 205 cm
MAX505STR	1	13	0,074	6,64	351	728	24	80 x 120 x 205 cm
MAX505H280	1	12	0,081	6,00	324	672	24	80 x 120 x 216 cm
MAX505H280S	1	12	0,081	6,93	324	672	24	80 x 120 x 216 cm
MAX505H280TR	1	11	0,088	7,00	297	616	24	80 x 120 x 216 cm
MAX505H280STR	1	11	0,088	7,93	297	616	24	80 x 120 x 216 cm
MAX520	1	17	0,058	4,48	459	952	36	80 x 120 x 238 cm
MAX520S	1	17	0,058	4,92	459	952	36	80 x 120 x 238 cm
MAX520TR	1	17	0,058	5,96	459	952	36	80 x 120 x 238 cm
MAX520STR	1	17	0,058	6,40	459	952	36	80 x 120 x 238 cm
MAX540H190	1	13	0,074	5,81	351	728	24	80 x 122 x 235 cm
MAX540H190S	1	13	0,074	6,47	351	728	24	80 x 122 x 235 cm
MAX540H190TR	1	13	0,074	7,35	351	728	24	80 x 122 x 235 cm
MAX540H190STR	1	13	0,074	8,01	351	728	24	80 x 122 x 235 cm
MAX540H245	1	11	0,090	6,46	297	616	18	80 x 122 x 222 cm
MAX540H245S	1	11	0,090	7,32	297	616	18	80 x 122 x 222 cm
MAX540H245TR	1	11	0,090	8,00	297	616	18	80 x 122 x 228 cm
MAX540H245STR	1	11	0,090	8,86	297	616	18	80 x 122 x 228 cm
MAX620H250	1	8	0,124	8,38	216	448	14	80 x 120 x 225 cm
MAX620H250S	1	8	0,124	9,54	216	448	14	80 x 120 x 225 cm
MAX620H250TR	1	8	0,124	9,90	216	448	14	80 x 120 x 239 cm
MAX620H250STR	1	8	0,124	11,10	216	448	14	80 x 120 x 239 cm
MAX620H340	1	6	0,160	9,70	162	336	10	80 x 120 x 206 cm
MAX620H340S	1	6	0,160	11,22	162	336	10	80 x 120 x 206 cm
MAX620H340TR	1	6	0,160	11,22	162	336	10	80 x 120 x 215 cm
MAX620H340STR	1	6	0,160	12,74	162	336	10	80 x 120 x 215 cm
MAX750H280	1	5	0,170	12,25	135	280	12	83 x 120 x 212 cm
MAX750H280S	1	5	0,170	13,85	135	280	12	83 x 120 x 212 cm

PACKING LIST WATERPROOF CASES MAX RANGE

<i>CODICE ARTICOLO ARTICLE NUMBER</i>	<i>N. PEZZI CONFEZIONE N PIECES PER CARTON</i>	<i>N. PEZZI M3 PIECES PER M3</i>	<i>CUB. IMB. PACKAGING CUBIC VOLUME</i>	<i>PESO CARTONE KG WEIGHT OF THE CARTON IN KG</i>	<i>N. PEZZI X CONTAINER 20' PCS X 20' CNT FLOOR LOADED</i>	<i>N. PEZZI X CONTAINER 40' PCS X 40' CNT FLOOR LOADED</i>	<i>N. CARTONI X PALETTA CARTONS X PALLETS</i>	<i>DIMENSIONI PALETTE PALLET DIMENSIONS</i>
MAX750H400	1	4	0,230	14,40	108	224	10	83 x 120 x 240 cm
MAX750H400S	1	4	0,230	15,75	108	224	10	83 x 120 x 240 cm
MAX820	1	3	0,331	19,00	81	168	4	80 x 120 x 240 cm
MAX820S	1	3	0,331	24,00	81	168	4	80 x 120 x 240 cm
MAX800	1	12	0,082	7,65	324	672	28	88 x 120 x 232 cm
MAX800S	1	12	0,082	9,11	324	672	28	88 x 120 x 232 cm
MAX800GPB	1	12	0,082	9,11	324	672	28	88 x 120 x 232 cm
MAX800SAD	1	12	0,082	9,11	324	672	28	80 x 120 x 232 cm
MAX1100	1	9	0,110	9,21	243	504	18	83 x 120 x 220 cm
MAX1100S	1	9	0,110	10,07	243	504	18	83 x 120 x 220 cm
MAX1100GPB	1	9	0,110	9,87	243	504	18	83 x 120 x 220 cm
MAX1100SAD	1	9	0,110	9,87	243	504	18	83 x 120 x 220 cm
SPUMAX001	16	1264	0,013	0,62	34.128	70.784	24	80 x 133 x 233 cm
SPUMAX002	8	632	0,013	0,46	17.064	35.392	24	80 x 133 x 233 cm
SPUMAX003	3	237	0,013	0,42	6.399	13.272	24	80 x 133 x 233 cm
SPUMAX004	2	158	0,013	0,42	4.266	8.848	24	80 x 133 x 233 cm
SPUMAX235H105	10	196	0,051	1,99	5.292	10.976	48	80 x 120 x 226 cm
SPUMAX235H155	6	117	0,051	1,59	3.159	6.552	36	80 x 120 x 230 cm
SPUMAX300	5	98	0,051	1,95	2.646	5.488	36	80 x 120 x 230 cm
SPUMAX430	5	33	0,110	2,50	1.215	2.520	15	90 x 120 x 234 cm
SPUMAX465H125	5	45	0,110	2,81	1.215	2.520	20	90 x 120 x 230 cm
SPUMAX465H220	5	33	0,150	4,55	891	1.848	15	90 x 120 x 235 cm
SPUMAX505	5	33	0,150	3,75	891	1.848	15	90 x 120 x 234 cm
SPUMAX520	4	26	0,150	3,06	702	1.456	15	90 x 120 x 234 cm
SPUMAX540H190	4	20	0,191	4,21	540	1.120	12	86 x 122 x 233 cm
SPUMAX540H245	3	15	0,191	4,15	405	840	12	86 x 122 x 233 cm
SPUMAX620H250	2	12	0,160	4,30	324	672	10	80 x 120 x 220 cm
SPUMAX620H340	1	6	0,160	3,52	162	336	10	80 x 120 x 220 cm
SPUMAX1100S	1	9	0,110	2,21	243	504	16	80 x 120 x 220 cm

PACKING LIST WATERPROOF CASES MAX RANGE

CODICE ARTICOLO ARTICLE NUMBER	N. PEZZI CONFEZIONE N PIECES PER CARTON	N. PEZZI M3 PIECES PER M3	CUB. IMB. PACKAGING CUBIC VOLUME	PESO CARTONE KG WEIGHT OF THE CARTON IN KG	N. PEZZI X CONTAINER 20' PCS X 20' CNT FLOOR LOADED	N. PEZZI X CONTAINER 40' PCS X 40' CNT FLOOR LOADED	N. CARTONI X PALETTA CARTONS X PALLETS	DIMENSIONI PALETTE PALLET DIMENSIONS
SPUMAX1100GPB	1	9	0,110	2,01	243	504	16	80 x 120 x 220 cm
CUBMAX001	30	2370	0,013	0,60	63.990	132.720	24	80 x 133 x 233 cm
CUBMAX002	14	1106	0,013	0,44	29.862	61.936	24	80 x 133 x 233 cm
CUBMAX003	6	474	0,013	0,42	12.798	26.544	24	80 x 133 x 233 cm
CUBMAX004	6	474	0,013	0,60	12.798	26.544	24	80 x 133 x 233 cm
CUBMAX235H105	8	312	0,025	1,90	8.424	17.472	12	80 x 133 x 233 cm
CUBMAX235H155	8	312	0,025	1,90	8.424	17.472	12	80 x 133 x 233 cm
CUBMAX300	8	634	0,013	0,56	17.118	35.504	112	80 x 120 x 225 cm
CUBMAX430	8	157	0,051	1,60	4.239	8.792	36	80 x 120 x 230 cm
CUBMAX465H125	16	144	0,110	3,24	3.078	8.064	20	90 x 120 x 230 cm
CUBMAX465H220	5	33	0,150	4,58	891	1.848	15	90 x 120 x 235 cm
CUBMAX505	8	72	0,110	2,55	1.944	4.032	20	90 x 120 x 227 cm
CUBMAX520	8	-	-	-	-	-	-	-
CUBMAX540	8	88	0,090	4,52	2.376	4.928	20	80 x 122 x 223 cm
CUBMAX620H250	8	50	0,159	4,56	1.350	2.800	10	80 x 120 x 220 cm
CUBMAX620H340	8	50	0,159	8,99	1.350	2.800	10	80 x 120 x 220 cm

PACKING LIST BLISTER PACKS

<i>CODICE ARTICOLO ARTICLE NUMBER</i>	<i>N. PEZZI CONFEZIONE N PIECES PER CARTON</i>	<i>N. PEZZI M3 PIECES PER M3</i>	<i>CUB. IMB. PACKAGING CUBIC VOLUME</i>	<i>PESO CARTONE KG WEIGHT OF THE CARTON IN KG</i>	<i>N. PEZZI X CONTAINER 20' PCS X 20' CNT FLOOR LOADED</i>	<i>N. PEZZI X CONTAINER 40' PCS X 40' CNT FLOOR LOADED</i>	<i>N. CARTONI X PALETTA CARTONS X PALLETS</i>	<i>DIMENSIONI PALETTE PALLET DIMENSIONS</i>
ART. 1 (55X45X12)	1200	14.117	0,085	5,17	381.159	790.552	24	80 x 120 x 219 cm
ART. 2 (55X45X20)	1200	14.117	0,085	5,17	381.159	790.552	24	80 x 120 x 219 cm
ART. 3 (55X45X30)	1200	14.117	0,085	5,17	381.159	790.552	24	80 x 120 x 219 cm
ART. 4 (75X45X12)	1200	12.631	0,095	6,47	341.037	707.336	24	80 x 120 x 219 cm
ART. 5 (75X45X20)	1200	12.631	0,095	6,47	341.037	707.336	24	80 x 120 x 219 cm
ART. 6 (75X45X30)	1200	12.631	0,095	6,47	341.037	707.336	24	80 x 120 x 219 cm
ART. 7 (95X45X12)	800	9.411	0,085	5,17	254.097	527.016	24	80 x 120 x 219 cm
ART. 8 (95X45X20)	800	9.411	0,085	5,17	254.097	527.016	24	80 x 120 x 219 cm
ART. 9 (95X45X30)	800	9.411	0,085	5,17	254.097	527.016	24	80 x 120 x 219 cm
ART. 10 (115X45X12)	800	8.421	0,095	6,81	227.367	471.576	24	80 x 120 x 217 cm
ART. 11 (115X45X20)	800	8.421	0,095	6,81	227.367	471.576	24	80 x 120 x 219 cm
ART. 12 (115X45X30)	800	8.421	0,095	6,81	227.367	471.576	24	80 x 120 x 219 cm
ART. 13 (135X45X12)	765	8.052	0,095	6,09	217.404	450.912	24	80 x 120 x 219 cm
ART. 14 (135X45X20)	765	8.052	0,095	6,09	217.404	450.912	24	80 x 120 x 219 cm
ART. 15 (135X45X30)	765	8.052	0,095	6,09	217.404	450.912	24	80 x 120 x 219 cm
ART. 16 (155X45X12)	680	7.157	0,095	6,81	193.239	400.792	24	80 x 120 x 219 cm
ART. 17 (155X45X20)	680	7.157	0,095	6,81	193.239	400.792	24	80 x 120 x 219 cm
ART. 18 (155X45X30)	680	7.157	0,095	6,81	193.239	400.792	24	80 x 120 x 219 cm
ART. 19 (195X120X30)	216	1.687	0,128	9,52	45.549	94.472	20	100 x 120 x 241 cm
ART. 20 (195X120X40)	216	1.687	0,128	9,52	45.549	94.472	20	100 x 120 x 241 cm
ART. 21 (220X45X20)	450	5.294	0,085	4,88	142.938	296.464	24	80 x 120 x 219 cm
ART. 22 (140X75X30)	640	5.663	0,113	10,49	152.901	317.128	18	83 x 120 x 233 cm
ART. 25 (180X90X40)	500	4.032	0,124	14,96	108.864	225.792	20	87 x 120 x 230 cm
ART. 27 (195X120X72)	210	1.640	0,128	10,27	44.280	91.840	20	100 x 120 x 241 cm
ART. 28 (90X65X20)	720	7.578	0,095	7,81	204.606	424.368	24	80 x 120 x 219 cm
ART. 29 (90X65X30)	720	7.578	0,095	9,25	204.606	424.368	24	80 x 120 x 219 cm
ART. 30 (90X65X40)	720	7.578	0,095	11,84	204.606	424.368	24	80 x 120 x 219 cm
ART. 30/29 (90X65X60)	720	7.578	0,095	11,84	204.606	424.368	21	80 x 120 x 247 cm
ART. 31 (220X45X30)	450	5.294	0,085	7,43	142.938	296.464	24	80 x 120 x 219 cm

PACKING LIST BLISTER PACKS

CODICE ARTICOLO <i>ARTICLE NUMBER</i>	N. PEZZI CONFEZIONE <i>N PIECES PER CARTON</i>	N. PEZZI M3 <i>PIECES PER M3</i>	CUB. IMB. <i>PACKAGING CUBIC VOLUME</i>	PESO CARTONE KG <i>WEIGHT OF THE CARTON IN KG</i>	N. PEZZI X CONTAINER 20' <i>PCS X 20' CNT FLOOR LOADED</i>	N. PEZZI X CONTAINER 40' <i>PCS X 40' CNT FLOOR LOADED</i>	N. CARTONI X PALETTA <i>CARTONS X PALLETS</i>	DIMENSIONI PALETTE <i>PALLET DIMENSIONS</i>
ART. 32 (180X45X20)	840	6.774	0,124	9,58	182.898	379.344	20	88 x 120 x 240 cm
ART. 33 (180X45X30)	840	6.774	0,124	12,10	182.898	379.344	20	88 x 120 x 240 cm
D 85	180	1.313	0,137	14,09	35.451	73.528	16	96 x 120 x 212 cm
E 30	180	1.313	0,137	8,69	35.451	73.528	16	96 x 120 x 212 cm
F 60	324	2.612	0,124	12,25	70.524	146.272	16	80 x 120 x 243 cm
A1	1050	20.588	0,051	14,50	555.876	1.152.928	36	80 x 120 x 237 cm
A2	1302	25.529	0,051	14,26	689.283	1.429.624	36	80 x 120 x 237 cm
B1	720	7.346	0,098	10,72	198.342	411.376	16	80 x 120 x 211 cm
B2	1200	12.244	0,098	15,04	330.588	685.664	16	80 x 120 x 211 cm
B3	490	4.188	0,117	10,92	113.076	234.528	16	80 x 120 x 207 cm
C1A	315	3.181	0,099	7,58	85.887	178.136	16	80 x 120 x 207 cm
C2A	540	5.454	0,099	6,68	147.258	305.424	16	80 x 120 x 207 cm
D0	500	4.050	0,123	11,12	109.350	226.800	12	80 x 120 x 204 cm
D0/4	250	2.032	0,123	5,77	54.864	113.792	12	80 x 120 x 204 cm
D1	500	4.065	0,123	16,27	109.755	227.640	12	80 x 120 x 204 cm
D2	310	2.520	0,123	10,43	68.040	141.120	12	80 x 120 x 204 cm
F1	240	1.578	0,152	13,72	42.606	88.368	12	81 x 123 x 207 cm
F2	120	1.176	0,102	8,35	31.752	65.856	21	82 x 125 x 225 cm
F3	120	1.061	0,113	11,03	28.647	59.416	18	81 x 126 x 213 cm
F4	165	1.833	0,09	11,01	49.491	102.648	24	87 x 120 x 236 cm

